

Organized and Trained for the Protection of Life and Property

THE INDIANA VOLUNTEER FIREMAN

THE ONLY VOLUNTEER FIREMEN'S ASSOCIATION
IN INDIANA WITH FUNERAL BENEFIT FUND
AND CLOTHING BENEFIT FUND



SPONSORED BY THE INDIANA VOLUNTEER
FIREMEN'S ASSOCIATION TO CREATE AND
PROMOTE GOOD-WILL AMONG ITS MEMBERS

VOL. 18 AUGUST, 1970 NUMBER THREE

IVFA Silver Anniversary Year

WEST CENTRAL INDIANA FIRE SEMINAR SEPT. 11-12

A West Central Indiana Fire Seminar will be held on September 11 and 12, 1970. This seminar, co-sponsored by the Indiana State Fire Marshal's office and the Safety and Fire Prevention committee of the Chamber of Commerce of greater Terre Haute, will be held in the Pfizer, Inc. auditorium, located about 4 miles south of Terre Haute on the west side of U. S. 41.

Friday's session will focus on industrial personnel, and the Friday night and Saturday sessions will deal with volunteer departments. A registration fee will be charged which will include one meal. Food will be served on the grounds.

Participants are asked to bring protective clothing to fight fires. The program is as follows: 633-4778

Friday 11, September

- 8:15 a. m. Registration
- 8:45 a. m. Invocation Father Joseph Beechem
- Welcome Allison Maxwell, Pres. C of C.
- 9:00 a. m. L. P. Gas Jerry Einstandig
- 9:45 a. m. Bus Fire Hazards George Tigner
- 10:45 a. m. Fire Safety Film Fire Marshal's Office
- noon Food Served on Grounds
- 1:00 p. m. Chicago Bomb Squad
- 3:30 p. m. Solvents-Petroleum Fires Terre Haute Fire Dept.
- Dinner Food Served on Grounds
- 6:00 p. m. Chicago Bomb Squad
- 8:30 p. m. Truck Markings Charles Baker

Saturday 12, September

- 9:30 a. m. L. P. Gas Jerry Einstandig
- 10:00 a. m. Truck Markings Charles Baker
- 11:15 a. m. Bus Fire Hazards George Tigner
- noon Food Served On Grounds
- 1:15 p. m. Solvents-Petroleum Fires Terre Haute Fire Dept. and Vol. Depts.
- 2:45 p. m. Burning Building Volunteer Departments

PREZ SEZ



As we start our second year it is easy to reflect on the past year, but at the same time we must look at and consider the future. The opportunities are

great, the responsibilities are tremendous.

The opportunity to serve you this past year was a fine and rewarding experience because of the fine group of officers you the members gave me to work with. We have made good progress because of this and, the great membership we have.

We have just completed the largest and certainly one of the finest conventions. A big bouquet to Carlos Jeffries, his Co-Chairman Don Hurst, the City of Shelbyville, District 10, and their fine Auxiliary who in such a short time did so much, it was just great.

Our Silver Anniversary year has just started. According to Crown Point it will end with the greatest convention yet. So, let us make 1970 our greatest year yet.

As we start this new IVFA year, in a new decade let us stop and assess the tremendous responsibilities that face us as citizens and firemen of the community in which we live.

I believe there is a concentrated effort going on in our country by various groups and individuals to overthrow what so many of us have worked so hard to build and keep.

Do we as parents assume the responsibility of our children, or do we believe that grandparents, babysitters, and school teachers have the responsibility to teach them manners, American Heritage, and how to live with and help their fellow man?

Do we as citizens assume complete responsibility we have to our community, or do we have a tendency to say, "I am a Fireman", I don't have time for the Red Cross, the Community Chest, the Boy Scouts, or the Girl Scouts? Do we say the church is good but I don't have the time? Do we say the Town Board, the Trustee and Advisory Board, or the City Council doesn't think much of the Fire Department because they didn't give us the money we thought we needed?

(Continued on Page 2)



OFFICERS AND MEMBERS IVFA

Gentlemen:

Once again we are starting a new fiscal year and we are ahead of the preceding year. Some 7,000 are recorded as of this writing and this is about 1,100 ahead of this time last year.

We had an increase of twenty new departments in the Nationwide Insurance program last year and we have many new ones for this year how many I have not as yet counted.

So to say we are off to a flying start is putting it mildly. Seems that through the efforts of the many past and present

officers plus all the membership we have built up a large ball of good things that has started rolling and it just keeps getting bigger and better. Again this year we also have some newly elected officers that are working hard and facing up to the problems at hand and they too will find success and give IVFA another additional boost.

Death has taken many of our loved ones during the past months and continues to do so. This we have no control over but we do honor our past members and would like to pay our tributes and benefits as soon as possible so keep reporting these events as soon as you can. This we have to depend on the individuals to do as all the Officers can not know what is going on unless told.

All dues that have been received in this office has been recorded and cards mailed out as of this writing. Cards are being mailed out within two weeks after I get them. Anyone that has waited longer for an answer from me please get in touch immediately. Your

(Continued on Page 2)

Officers Elected at Shelbyville Convention

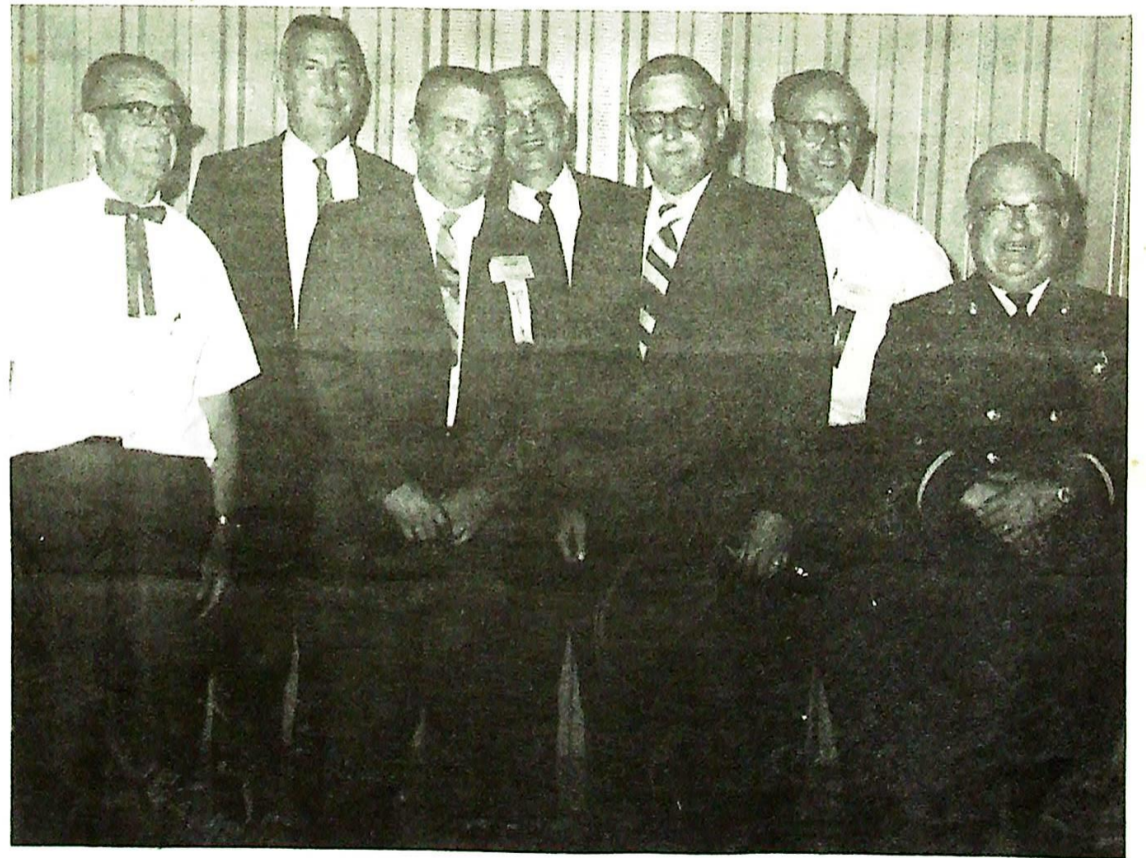

Left to right: Ray Lester, Sgt.-at-arms; Don Mason, Recording Secretary; Bill Engle, Vice President; Verne Konopasek, Treasurer; William Goodwin, President; Jack Ford, Secretary; Duane Lantz, Chaplain.



CROWN POINT WILL BE FUN IN '71

25th Anniversary Convention - June 10-11-12

THE INDIANA VOLUNTEER FIREMAN

Subscription Price — 50c Per Year

Published February, May, August, November. All items to be published should be in the Editor's office not later than the 20th of the preceding month.

ROBERT E. LANEY, Publisher and Editor

Second Class postage paid at the Post Office in Crown Point, Lake County, Indiana, under the Act of Congress of March 3, 1897.

Please send all correspondence and address changes to **The Indiana Volunteer Fireman, P. O. Box 437, Crown Point, Indiana 46307.**

AUGUST, 1970

ADVERTISING RATES

\$2.00 PER COLUMN INCH — 2-COLOR \$2.60 PER COLUMN INCH

Advertising space contracted for four (4) consecutive issues, a 10% discount will be allowed from total bill.

INDIANA VOLUNTEER FIREMEN'S ASSOCIATION OFFICERS

- | | |
|---|---|
| President - William Goodwin
300 W. Maumee St.
Angola 46703
219-665-3810 | Chaplain - Duane Lantz
Route 1, Box 750
LaPorte 46350
219-362-5718 |
| Vice President - Bill Engle
3307 Hillcrest Rd.
Vincennes 47591
812-882-1987 | Sergeant-at-Arms - Ray Lester
Route 3, Box 98
Rushville 46173
Phone Raleigh 2525 |
| Secretary - John Ford
3005 Lincolndale Ave.
Fort Wayne 46808
Phone Residence 219-483-5655
Phone Work 219-422-7474 | Recording Secretary - Donald Mason
P. O. Box 13
LaCrosse 46348
219-754-2489 |
| Treasurer - Verne Konopasek
145 West Elm St.
Griffith 46319
219-TE 8-1321 | Past President - Carlos Jeffries
P. O. Box 85
Fountaintown 46130
Res. Phone Morristown |

Public Relations Directors — Elected

- | | |
|--|---|
| Pub. Rel. NW - Harold King
R. 1, Box 766
LaPorte 46350
219-362-4953 | Pub. Rel. SW - Edgar Nigg
Haysville Rural Station
Jasper, Indiana 47546 |
| Pub. Rel. NE - Garland Kiefer
Burket 46508
219-491-2730 | Pub. Rel. SE - Paul L. Kraft
525 Spicewood Dr.
Jeffersonville 47130
812-945-0013 |

District Chairmen and Board of Directors

- | | |
|---|--|
| District 1 - Robert Esserman
R. 1, Box 354
Chesterton 46304
219-926-6686 | District 13 - James Baker
301 Lincoln Street
Greenfield, 46140
Phone 462-4335 |
| District 2 - Leon Lump
W. Commercial Ave.
Lowell 46356
219-696-8418 | District 14 - Sam Bower
Nabb 47147
812-773-4194 |
| District 3 - Roland Masters
R. 4, Box 275
LaPorte 46350 | District 15 - Wm. Coghill
Route 7, Box 190
Evansville 47712
Phone 963-5191 |
| District 4 - Norman Crocker
13432 State Rd. 23
Granger 46350 | District 16 - Gilbert Leist
216 Green St.
New Albany 47150
812-944-2545 |
| District 5 - William Price
Aetna Green 46524 | District 17 - Bert Ketchum
404 W. Main St.
Odon 47562 |
| District 6 - Paul Fairfield
5128 N. Bend Dr.
Fort Wayne 46804
219-432-2365 | District 18 - Merlyn J. Lueken
East 12th St.
Ferdinand 47532 |
| District 7 - Orin Brames
Box 109
Hoagland 46745
219-639-3378 | Editor - Robert Laney
Box 437
Crown Point 46307
219-663-0722 |
| District 8A - Ralph Hertle
Box 336
Gaston 47342
317-358-3244 | |
| District 8B - Ivan Bousman
Route 4, Box 201
Winchester 47394
Saratoga 2582 | |
| District 9A - Chas. Sutton
Burlington 46915
317-566-3057 | |
| District 9B - Edmund Weaver
Box 176
Francesville 47946
219-567-9243 | |
| District 10 - William E. Carman
R. R. 15, Box 12
Acton, Indiana 46259
317-862-6700 | |
| District 11 - Charles McGill
Box 1434
Dana 47847
812-566-3046 | |
| District 12 - Harold Stofer
718 S. Ingomar St.
Indianapolis 46241
317-241-1946 | |

PAST PRESIDENTS

- Harold Brownell**
Lowell 46356
- Cornelius Vander Vaart**
Munster 46321
- John Kustron**
Gary 46409
- Waldo Neal**
Geneva 46740
- Leonard Kunzler**
LaCrosse 46348
- Robert Widmar**
Bremen 46506
- Bert Moser**
Bluffton 46714
- John Ford**
Above
- Bernie Jostes**
Griffith 46319
- James Glaub**
Manilla 46150
- Walter Steiger**
Goshen 46526
- Carlos Jeffries**
Fountaintown 46130

NOTE FROM JACK FORD

How about that Convention in Shelbyville? They just keep getting bigger and better. I shall never forget it and most of you know why.

As recipient of the Paul Becker Memorial Award I wish to take this means of thanking the many that have encouraged and helped me these many years to attain the qualifications that enabled me to be considered for this award. To those that recommended me I owe much more and to the President, William Goodwin, goes my deepest thanks. I am sure that each one of you at some time have wanted to put things in words that give you quite a bit of difficulty and such is the case now. Well, however you got out of that personal difficulty same goes for me. THANKS.

Jack Ford

SECRETARY'S REPORT

(Continued from Page 1)

cards have been lost and I shall be most happy to make a duplicate set out for your department. I have a few listings that try to get by without returning three copies of each listing for office use. These, however, do not get by as I make out a third copy and this takes some time that could be used for other work. Please send three copies as it sure does help with the filing.

I wish to take this method of thanking each and every member for the faith and confidence placed in me by being elected Secretary for another year. I am very happy to serve you and hope that throughout the coming year I can serve you in the manner of which you deserve and expect.

This office is never to busy with other things that it does not have time for your questions or requests, so if you have anything, please feel free to fire away. I shall do my best to see that all is taken care of promptly.

Again, thank you for your support, pardon all my mistakes—they were not at all intentionable, and above all thanks for all your help.

Respectfully,
John T. Ford, Secy.

Marion Co. Volunteer Firemen's Association 1969 Fiscal Report

The following, although late, is the compiled figures and statistics for 1969 of member departments of The Marion County Volunteer Firemen's Association. I apologize for its tardiness however, as everything is running about 6 months behind due to my unexpected and unwanted 6 month's vacation last September.

15 Fire Departments comprise The Marion County Volunteer Firemen's Association, serving approximately 280 square miles with a population of 481,500 residents based on the 1965 census.

15 Fire Departments, operating out of 32 station houses, manned by 1500 men, averaged 441 runs per station in 1969. Of the 1500 men, 613 are qualified and fully trained ambulance drivers and medical technicians.

5 Dispatch Centers handled the chores of disbursing the 14,093 runs of which 4,175 were fire, 4,663 rescue and first aid, and 5,255 ambulance trips to the hospital.

The apparatus making the 14,093 runs break down as follows: 78 fire apparatus, 20 rescue units, 20 ambulances and 8 chief vehicles.

This report does not include apparatus on order, or station houses under construction.

Figures are not available on property values, property losses, fatalities, or injuries.

Gene Battaly
Public Information Director
Mar. Co. Vol. Firemen's Assn.

PREZ SEZ

(Continued from Page 1)

Do we criticize the officers of the Fire Department we belong to, or the men that are active on it because they go to most of the Alarms. Do we make suggestions that are good, do we sell our share of the dance tickets, do we participate in the training program completely? Do we help plan, do we help others learn by teaching?

If your answer to these questions is partially yes and you're not ready to stand up and be counted, and say "Hell no" I advise you not to plan many years in the Future because you won't have a chance to plan and somebody else will be telling you what to do and how to do it.

I challenge each and every one of you to become totally involved in all of community, church, and country affairs. Become totally involved to your responsibility to your family.

We have assumed the awesome responsibility to protect our fellow man, so let's each one of us stand up today and say thank God I live in America, and I am going to help make it even greater than it is now.

If we each do this I know my fellow man in Indiana will receive the Fire Prevention and Fire protection he is richly deserves.

Lost, Strayed, Or Hidden!!!

At the last IVFA convention, George Malo of the Cedar Lake Fire Department, used one green, hand siren; which was the property of Bob Rose, of Cedar Lake, who was unable to attend. Someone borrowed the siren from the Cedar Lake boys, and failed to return it.

The siren has a lot of sentimental value as it has followed the Cedar Lake Department to the last 25 conventions, and has been borrowed and used by many of the volunteers over the years. It has always come home before. Not so, this time! . . .

If the person who has borrowed it will please return it, it will be greatly appreciated. Send it to Bob Rose, P. O. Box 355, Cedar Lake, Indiana 46303.

A reward is offered. The reward being, exclusive rights to use the siren at the next convention which will be held in Crown Point.

Public Relations Northwest

Well, we are in another year of activities. I wish to thank all who had a little part in my being elected again. I will try that much harder to do my job.

I was honored by District I Chairman in being given the job of conducting their District election. Bob Esserman and his Secretary, Vernon Jones were re-elected for the coming year. President Goodwin attended the meeting at Merrillville. A very good meeting on July 19th.

Your P. R. N. W. and Chaplain Lantz and families were invited to District 4 picnic. There, again, I was asked to conduct the election and with the help of the Chaplain we got the job done. Again Chairman Norm Crocker was elected Chairman; Vice Chairman Butch Smeltzer and Secretary Dale Maxwell.

The weatherman was reasonably good until all things were over then he really cut loose with a lot of hard rain.

I wish to remind all that I will be available to give all a hand who wish it. Thanks, Jeff and Don Hurst for a good convention and all your helpers, including the Staffords, did a fine job. Let's all work together for more success for the IVFA, Inc. The fellowship of the men and women in our organization certainly is the greatest. District 4 has some real water ballers, let's all try for some of this fun and games.

Lest I forget, I also had the honor of conducting District 3 election. We have a new District Chairman in Ron Master-son, Chief of the Kingsbury Dept. and Ralph Yergler was re-elected as Secretary.

The future District meetings will be as follows: Springfield Twp. August 20th; September 17th, Coolspring Twp. Let's get the boys out for these meetings.

Again I urge you to support your Department and District meetings and District Officers as well as your State Officers. I think they all have a big job cut out for them.

Come out to Springfield's meeting and see their new station and equipment. It sure is great. These boys put a great amount of time and effort to have what they can say is theirs.

In District 4 Harris Twp. hosted the picnic and Penn North let them use their station and facilities for the meeting and games. That is real cooperation.

This fall is Government elections and after, as well as before, visit and talk to the candidates—telling them what the Volunteers need. Modern laws in our Fire Marshals Office. This is the only way we can come up with some of the things we need.

Come on Crown Point for 71. I know you can do it! If not before I will try and see you there.

Harold L. King
Public Relations Northwest

HOOSIER FIRE EQUIPMENT
AMERICAN LaFRANCE

FECHHEIMER &
CAPITOL UNIFORMS

LAUGHMAN FIRE & SAFETY EQUIPMENT, INC.

4181 WILLOW AVENUE - PHONE 691-3332

ROUTE 4 - COLUMBIA CITY, INDIANA 46725

HOOKEFAST SPECIALISTS AMERICAN FLAG PATCHES CUSTOM MADE FLAGS & BANNERS INSIGNIA & EMBLEMS

In Memoriam

Alonzo "Lon" Daugherty—East Gary
 Maurice Linder—St. Paul
 J. Thomas Moore—Dunreith
 Wilbur House—New Lisbon
 Robert Gilman—Hymera
 Edward Stark—Wayne No. 1, Ft. Wayne
 Frank Deli—San Pierre
 Raymond Tievault—Tippecanoe
 Howard J. Wiegel—Geneva Twp., North Vernon
 Lorenzo N. Bailey—Burnett
 Lester E. Sheets—Decatur

New Officers of Ladies' Auxiliary



Left to right: Thelma Lester, Chaplain; Mary Stafford, Immediate Past President; Verta Engle, Treasurer; Catherine Mason, Sgt.-at-arms; Jo Lantz, Recording Secretary; Joan Shanabarger, Corresponding Secretary; Rosella Bousman, President.

St. Joe Captures Hose Replacement Contest

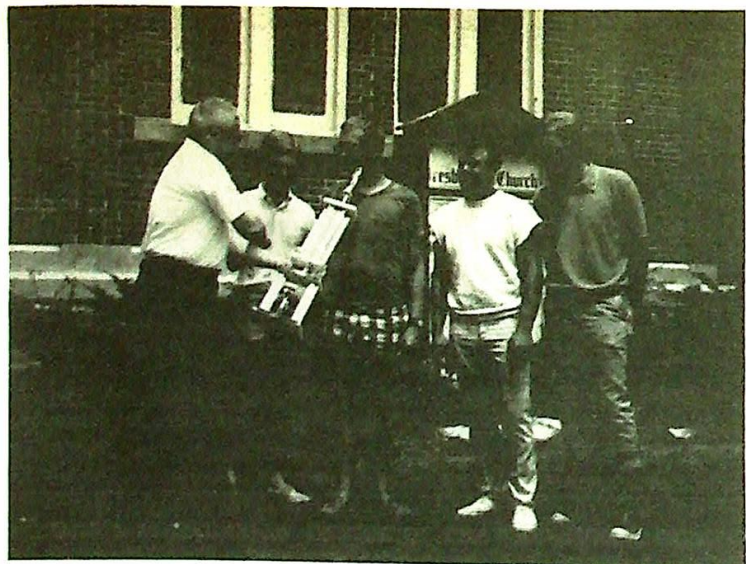

LaOtto No. 1 Places Second in Hose Replacement



New Unit For Fleming Garden Volunteers



This is a new unit recently delivered to the Fleming Garden Volunteer Fire Dept. Co. No. 3 of Wayne Township, Marion County. It is a Fire Rescue Unit carrying the following equipment: rescue saw, acetylene cutting outfit, resuscitator, stretchers, extra oxygen, blankets, smoke ejector, back boards, air masks, air tanks, and all fire equipment as per Pamphlet No. 19, including 1,200 Feet of 3" Yellow 100% Dacron Fire Hose. It has a 12,000 lb. front mounted winch and a portable A-frame that mounts on the front platform. Also there are four (4) 500 Watt Idion Quartz lights mounted above the pump. The lights are on sliding up and down posts. It also has a 3,500 Watt AC PTO driven generator and a 1000 G. M. 2-Stage Waterous fire pump. This apparatus is mounted on a 1970 Ford C900 with a Howe Fire Apparatus Co., of Anderson, Indiana Custom Canopy Cab. (Citizen Photo)

Nationwide Presents Check for \$30,000



Left to right: Robert McKean, Nationwide Insurance Co., Special Groups Manager; Richard Lamb, Chief of Wayne Township Fire Department, Marion County; Harold Stofer, IVFA Chairman 12th District; and George Flickinger, Nationwide Insurance Co., District Group Sales Manager.

The broader benefits contained in the IVFA sponsored accident insurance policy came into sharp focus when a deputized bystander (a volunteer fireman from a nearby department) suffered a fatal heart attack while directing traffic at a recent fire. The victim was pressed into action by volunteer fire officials and therefore became eligible for coverage under their department's accident insurance policy underwritten by Nationwide Mutual Insurance Company.

His estate received a check for \$30,000 as a result of the loss which was \$10,000 in excess of the \$20,000 maximum required by Indiana statutes.

Robert McKean, Special Groups Manager for Nationwide and George Flickinger, District Group Sales Manager, are pictured presenting the check to IVFA District No. 12 chairman, Harold Stofer and Chief Richard Lamb of the Wayne County Fire Department.

McKean and Flickinger pointed out that the special benefits which enabled Nationwide to

pay this sum are generally not available under other policies where payments are limited to accidents occurring to firemen while in the performance of their duties. Coverage for heart and circulatory malfunctions and deputized bystanders has been a part of the IVFA policy since its inception in 1961.

Other special features in addition to the increased death

benefit, the heart and circulatory malfunction benefit and the bystander coverage includes increased benefits for total disability; no territorial restrictions; and Ladies' Auxiliary coverage.

Member companies can get further information by writing: John T. Ford, Secretary, IVFA, 3005 Lindolndale Avenue, Ft. Wayne, Indiana 46808.

60 YEARS OF SAFETY AND SERVICE—ESTABLISHED 1910

PEOPLES FEDERAL SAVINGS & LOAN ASSOCIATION

OF EAST CHICAGO, INDIANA

Start an Insured Savings Account
 And Add To It Regularly

Three Locations to Serve You
 4902 Indianapolis Blvd., East Chicago, Indiana
 Phone EX 7-5010

INDEPENDENCE HILL BRANCH 7915 Taft Street Merrillville, Indiana Phone 769-8452	WOODMAR BRANCH 7135 Indianapolis Blvd. Hammond, Indiana Phone 844-7210
---	---

Mr. IVFA 1970



Mr. Edgar Nigg of Haysville was selected as Mr. IVFA at the Shelbyville Convention. Mr. Nigg who is serving as Public Relations Director Southwest has done much to help promote the IVFA in his area of the state. Our congratulations go to Edgar and keep up the good work.

70-71 Public Relations Directors



Elected for the coming year are our four Public Relations Directors: Left to right: Garland Kiefer NE, Edgar Nigg SW, Paul Kraft SE and Harold King NW.

To All IVFA Members:

We, of Wayne Township, Marion County, would like to thank all of you for giving us an opportunity to host your 1972 Convention. As soon as we came home from the wonderful convention in Shelbyville, we started to work for 1972.

Harold (Gene) Stofer, District 12, IVFA Chairman, will be the

Convention Chairman. He plans to give you a convention you will never forget. But, most of all, have a good time at Crown Point in 1971 and we will be looking forward to seeing you in "72".

Faithfully yours,
Wayne Township Fire Dept., Inc.
Indianapolis, Indiana
Richard C. Lamb, Fire Chief

Indiana Volunteer Firemen's Association, Inc.

Non-Profit Organization #35-602-6503 (256566-08)

Treasurer's Financial Report to the Officers and Delegates to the Shelbyville

Convention of June 11, 1970

Continued from the reverse side hereof - Period June 1, 1969 to June 1, 1970

"CLOTHING FUND ACCOUNT"	6-1-69	1-1-70	TOTALS	EXTENDED TOTALS
	to 12-31-69	to 6-1-70		
RECEIPTS				
Balance on hand				
Warsaw Convention 6-1-69 (As reported)....				11224.03
Secretary's reports #16 & 17 (68-69) 9	4.50		4.50	
Secretary's reports #4 thru 16 (69-70) 9487	4743.50		4743.50	
Secretary's reports #17, 18 & 19 (69-70) 257		128.50	128.50	
Secretary's reports #1, 2 & 3 (70-71) 1186		593.00	593.00	
TOTALS (Active members 10939)	4748.00	721.50	5469.50	16693.53
"DISBURSEMENTS"				
Ck. #861 thru 907 (inc. 5-Eye Glasses).....	947.01		947.01	
Ck. #908 thru 969 (inc. 11-Eye Glasses).....		1301.62	1301.62	
TOTALS 108 Claims	947.01	1301.62	2248.63	2248.63
Balance on hand				
Shelbyville Convention 6-1-70				14444.90*

"EMERGENCY - DONATION & RESERVE FUND ACCOUNT"				
RECEIPTS				
Balance on hand				NONE
Warsaw Convention 6-1-69 (New Account)				
Donations - Nation-Wide Ins. Co.				
Fees 778.60*	1889.62		1889.62*	
Donations - Reserve Interest Div. 1969.....	3373.51		3373.51x	
Donations - Ladies' Auxiliary	500.00		500.00	
Donations - Nation-Wide Ins. Co.				
Fees (5-Mo. of 1970)		1248.30	1248.30*	
Donations - Reserve Interest Div. (First 5-Mo. of 1970)		820.63	820.63x	
Ret'd from Gen. Fund to Balance (778.60 minus 750.00**	28.60		28.60	
**1969 Legislative Comm. Expense (750.00)				
TOTALS	5791.73	2068.93	7860.66	7860.66
DISBURSEMENTS				
New Account - Bank Charges, Print Checks, etc.	8.63		8.63	8.63
Balance on hand				
Shelbyville Convention 6-1-70				7852.03*

"GENERAL FUND ACCOUNT"				
RECEIPTS				
Balance on hand				19165.98
Warsaw Convention 6-1-69 (as reported)....				
Individual membership dues (68-69).....	15.75		15.75	
Individual membership dues (69-70).....	17363.00	454.75	17817.75	
Individual membership dues (70-71).....		2188.00	2188.00	
Deposits and Overpayments received	496.50	29.50	526.00	
Donations - IVFA Newspaper Ads	503.80	561.06	1064.86	
Donations - Conv. Program Ads-Warsaw.....	4000.00		4000.00	
Donations - Conv. Registrations-Warsaw.....	3517.00		3517.00	
Donations - For Decals	2.00		2.00	
Gary Nat'l Bank - RI-206636 and RI-206637 Cks.	96.00		96.00	
TOTALS	25994.05	3233.31	29227.36	48393.34

DISBURSEMENTS				
General Convention expense	6161.32	13.49	6174.81	
General Convention Printing expense	934.90	81.25	1016.15	
Regular Printing expense	2557.14	1063.92	3621.06	
IVFA Newspaper - Printing expense	3427.72	1235.10	4662.82	
Officers and Committee meeting expense.....	1705.47	1717.91	3423.38	
Postage & phone (inc. Newspaper & Conv.)....	1759.65	994.31	2753.96	
Misc. District expense	794.36	646.80	1441.16	
Office Supplies & Equipment	731.95	223.12	955.07	
Deposits & overpayments refunded	491.50	32.50	524.00	
Secretary's Expense	1129.10	810.70	1939.80	
Editor's Expense	516.85	540.25	1057.10	
Treasurer's Expense	534.88	412.50	947.38	
President's Expense	450.38	180.00	630.38	
Vice-President's Expense	140.02	35.80	175.82	
Past-President's Expense	43.10		43.10	
Chaplain's Expense	223.50	150.00	373.50	
Public-Relations Expense	107.00	58.50	165.50	
Serg.-At-Arms Expense	105.40	15.00	120.40	
Recording Secretary's Expense	20.00		20.00	
Chrmn. of Board Expense	15.20	7.60	22.80	
BOND - Insurance premium	666.00		666.00	
Officers Ins. Premium - Marsh & McL.....	485.00		485.00	
Television - Promotion Expense	45.00		45.00	
Gary Nat'l Bank - RI-206636 & RI-206637 Cks.	96.00		96.00	
50-Year Engraved membership Cards		38.99	38.99	
State of Indiana - Non-Profit Organ. Fee.....		1.00	1.00	
TOTAL Disbursements 6-1-69 to 6-1-70....	23141.44	8258.74	31400.18	31400.18
Balance on hand				16993.16*
Shelbyville Convention 6-1-70				

Respectfully submitted,

Verne Konopasek 6-1-70
Treasurer, 145 West Elm St.
Griffith, Indiana 46319

FESCO



HUGH HAZELIP

OUR NEWEST "REDCOATSMAN"

Hugh is covering Southern Indiana.
Complete line of Fire Dept. Supplies.

PLUS — American Fire Apparatus - Hahn Custom Pumps

Fire Equipment Service Co.

868 So. 21st St. Louisville, Ky. 40210

CALL US COLLECT - 502-776-1551

FLAG PRESENTATION



Ernest Cardenas, representing Gary Memorial American Legion Post 17, presents Indiana and United States flags to the Camp 133 Fire Department. From left are: Cardenas; Assistant Fire Chief Edward C. Bible; Mrs. Byford Cook, president of the firemen's auxiliary; Mrs. Kenneth Reberg, vice president of the auxiliary, and Captain Kenneth Reberg. (Post-Tribune photo)

Jack Ford Honored with Paul Becker Memorial Award

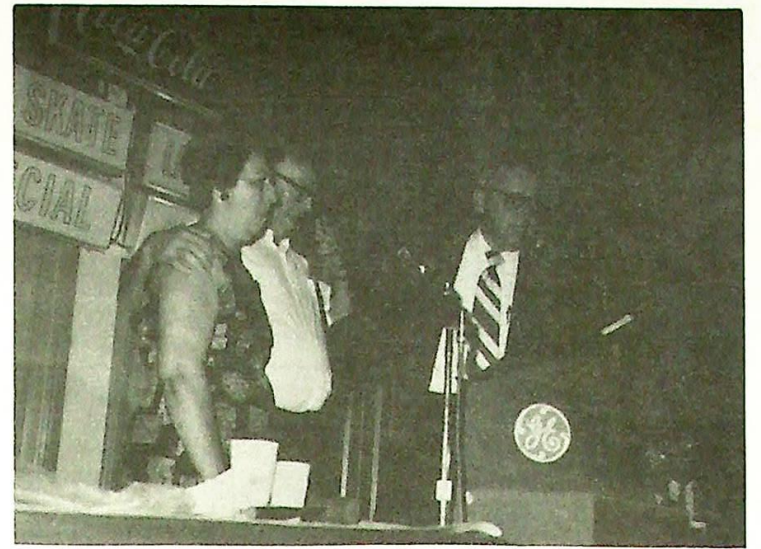

The Paul Becker Memorial Award presented at the State Convention by President William Goodwin went to Jack Ford, IVFA Secretary. Shown above are Ruth and Jack Ford receiving congratulations from Mr. Goodwin.

District Meetings

DISTRICTS ONE AND TWO

The July meeting of Districts 1 and 2 was held at the Merrillville Fire Station on Wednesday, the 15th. The meeting was opened with the pledge to the Flag, led by Treasurer Verne Konopasek. Seventy-five men from 19 departments answered roll call. Present also was President William Goodwin, Chaplain Duane Lantz, NW Public Relations Harold King and Frank Parillo of the Fire Marshal's Office.

A demonstration was given by two N.I.P.S.C.O. linemen showing how to Resuscitate a victim of electrical shock while bringing him down a pole. A question and answer session followed.

The District 1 and 2 picnic was held at Lakewood Park, north of Valparaiso, Sunday, August 9th. The Water Ball contest was at Chesterton at 8:00 A. M.

The Resuscitation School was set for September 26th and October 3rd. The committee reported that final preparations are being made and letters and registration forms were mailed out the first week in August.

A registration form appears elsewhere in this paper.

Harold King conducted the District Office elections with Robert Esserman and Vernon Jones re-elected chairman and secretary of District One. District Two elections were not held due to not enough departments being represented at the meeting.

The highlight of the evening was a Fifty-year Fire Service Award to Verne Konopasek,—a fifty year member of the Griffith Fire Department. Making the presentation was President Goodwin and Chaplain Lantz. The award was a complete surprise to Verne who was given a standing ovation.

A talk on the State Fire Marshal's Office was given by Frank Parillo.

A history of the Merrillville Fire Department was read and Chief William Markle introduced his men. Along with their other fine equipment on display was their new W. S. Darley Rescue-Pumper.

The meeting was closed with a delicious lunch served by the Ladies' Auxiliary.

The August meeting was held (Continued on Page 11)

Konopasek honored with Gold Lifetime Membership Card



Left to right: Duane Lantz, IVFA Chaplain; Verne Konopasek, State Treasurer, receiving the award, and William Goodwin, State President.

Verne Konopasek (old money bags), IVFA Treasurer was honored at the District I and II meeting at Merrillville Fire Station. Verne has been a member of the Griffith Volunteer Fire Department for the past 50 years. Making the presentation to Verne was William Goodwin State President.

all persons attending five classes. Full protective clothing will be required for participants.

Lunch will be provided by the Ladies' Auxiliary at an additional charge. Free overnight camping will be available for those desiring to stay over. All classes will be open for fire fighters wives.

Reservations should be sent in by September 12 to one of the following:

- Gerald McClanahan
23135 Adams Rd.
South Bend, Indiana 46628
- Jasper Michael
26281 Stroup Dr.
South Bend, Indiana 46628
- Charles L. Schafer
R. R. 1
20930 Osborne Rd. W.
Lakeville, Indiana 46536

St. Joseph County Fire-Fighters Association

Fire Conference and School

The St. Joseph County Fire-Fighters invite you to attend a conference and fire school on September 26 and 27, 1970 at the Crumstown Fire Station on Crumstown Highway, west of South Bend.

Instruction will be on pit fires, foam, masks, explosives, electrical (High and Low Voltage), ladders, anhydrous ammonia, identification of cargo, and use of the backboard.

There will be a \$1.00 registration fee, with registration starting at 9:00 A. M. and classes dismissing at 4:00 P. M. Certificates will be issued to



SECURITY FEDERAL SAVINGS

AND LOAN ASSOCIATION OF LAKE COUNTY

MORTGAGES ON HOMES AND BUSINESS

4 Convenient Offices

DARLEY CHAMPION DIESEL PUMPER

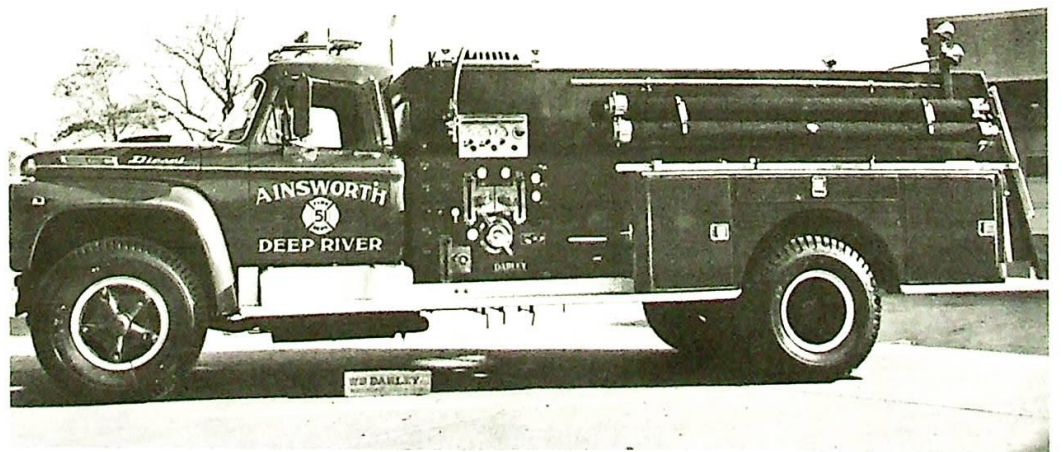

If you are considering diesel power for your new pumper, W. S. Darley & Co. can supply it.

1000 GPM three stage midship pumper with

1000 gallon tank.

Caterpillar 225 horsepower engine.

Ainsworth-Deep River—Hobart, Indiana

W. S. DARLEY & CO.

ESTABLISHED 1908

2000 ANSON DRIVE

(Suburb of Chicago)

MELROSE PARK, ILLINOIS 60160

Angola Breathed Easier After Explosion Threat

Angola's safety was threatened recently when a large amount of gasoline was accidentally spilled in the north-west part of the city. Just how serious the threat was became apparent in a report made by Angola Fire Chief Bill Goodwin.

At 6:45 a. m. on July 21, the Angola Fire Department received a call to flush a gasoline spill at the Farm Bureau on West Mill Street. This started one of the most dangerous days for the City of Angola.

Many safeguards are taken by the Steuben County Farm Bureau to protect its property, employees and neighbors, but the human element can break down the finest of safety precautions.

According to the report Donald Silberman, a gasoline transport driver, arrived at the Farm Bureau to pump off his load. First he started to pump the gasoline into the wrong tank, then he got back into his truck and apparently went to sleep. About forty minutes later Bill Sutton, who lives nearby, smelled gasoline and upon investigation, found the tank overflowing and the driver asleep.

When the Angola Fire Department arrived on the scene the driver told them he thought about 100 gallons had been spilled. Upon investigation they found gasoline running six inches deep some three to four hundred feet north through the Catholic Church property which runs from Broad Street to the Moore Business Forms property on Mill Street. Upon further checking it was estimated that some 4500 gallons of gasoline had been spilled.

At this time a call was sent to Kendallville Fire Department for their foam unit and plans were developed to cover the exposed area with sand. The foam unit was on the scene and a cover of foam was soon over the exposed gasoline. An emergency call was placed to Fort Wayne for more foam and it was rushed to Angola in less than an hour.

Flushing of storm sewers in the area was started and State Conservation units were called in to check the area around Center Lake where the storm sewer empties.

The Angola Police Department officers were on the scene from early morning until late in the evening controlling the



(Continued on Page 7)

INDIANA VOLUNTEER FIREMEN'S ASSOCIATION, INC.

A NON-PROFIT ORGANIZATION—ID 35-602-6503

Death Benefit - Funeral Fund Department - Shelbyville 1970 Convention Report

June 1, 1970

The Following Contributions made to Beneficiaries Account Deaths Reported

June 1, 1969 to June 1, 1970

x—Indicates Family Desired Memorial Bible					*—Indicates Additional Memorial (not Bible)				
Date	Town	Claim No.	Name	Card No. Age Amt.	Date	Town	Claim No.	Name	Card No. Age Amt.
5-26-69	592		Roy Edgar Hasty	80	10-26-69	611		Harry Fries	76
Laud D-6			1465	100.00x	Koontz Lake D-3			523	100.00x
6-3-69	593		Ray Lee Ellis	39	-69	612		William Oren	67
Jackson Twp. R. 1					Gas City D-8A			10840	110.20*
Gentryville D-18			2578	65.00x	11-21-69	613		Dean Briggs	49
6-15-68 OK	594		Thomas J. Kuntz	50	Flora D-9A			8602	100.00x
McCulloch R-12					12-6-68 OK	614		Jack Sloan	58
Jeffersonville D-16			12518	110.20*	Windfall D-9A			11139	65.00x
5-27-69	595		Herbert Black	62	12-1-69	615		Wilbur C. Cochran	72
Uniondale D-7			3159	110.20*	Burket D-5			3219	100.00x
6-2-69	596		Harve Zellers	78	11-21-69	616		Howard H. Langlois	55
Winamac D-9B			5912	110.20*	Bass Lake D-3			12485	110.20*
4-25-69	597		George Snow	63	12-5-69	617		James Webb	38
Chester Twp. R. 1					Duck Creek Twp. R. 1				
Poneto D-7			12444	110.20*	Elwood D-9A			15804	110.20*
7-19-69	598		Burrell Stafford	58	12-12-69	618		William J. Schlessler	70
Sheridan D-12			2050	110.20*	Schererville D-1			82	110.20*
8-7-69	599		Charles M. Brown	77	10-14-69	619		Orville Larrison	60
Wash. Twp., Fort Wayne					Converse D-8A			13344	100.00x
D-6			1700	100.00x	12-7-69	620		Leon Williams	55
8-7-69	600		Alan Cooper	33	Roachdale D-11			4574	100.00x
Merrillville D-1			1746	35.00x	12-12-69	621		Donald A. Hall	60
7-22-69	601		Donald Brehob	36	Perrysville D-11			14746	100.00x
Bass Lake D-3			15052	100.00x	12-18-69	622		Earl E. Doane	72
12-27-68	602		Paul W. Purkhiser	40	Covington D-11			6871	100.00x
West Baden D-18			14439	65.00x	12-20-69	623		Elmer P. Miller	61
8-29-69	603		Carl Kleins	70	Dyer D-1			366	100.00x
Franklin Twp. 2					12-20-69	624		John D. Miller	36
Acton D-10			13965	110.20*	Wayne Twp 10				
8-20-69	604		Herman Dierkes	66	Clermont D-12			13779	110.20
Decatur D-7			1203	110.20*	12-21-69	625		James H. Keller	55
1-25-68 OK	605		Glen Bell	42	New Market D-11			2724	100.00x
Mexico D-5			3254	100.00x	12-23-69	626		Herman A. Chapel	56
9-14-69	606		Richard Clark	30	Swayzee D-8A			5482	100.00x
Porter D-1			6914	65.00x					
10-2-69	607		John Huppenthal	61					
Schererville D-1			2237	110.20*					
9-30-69	608		George Hendricks	78					
Madison Twp.									
Mulberry D-9A			16824	100.00x					
10-7-69	609		Elmer E. Beck	70					
Chesterton D-1			26	110.20*					
10-22-69	610		Henry Radiger, Sr.	85					
Chesterton D-1			29	100.00x					

Sub-Total Listings (35) 6-1-69 to 1-1-70 3437.80

(does not include the cost of memorials See Funeral Fund Summary below) Our overall Av. age at death - 60



1-10-70	627		Paul Schramm	40	4-4-70	637		Kenneth Brady	58
Ainsworth DR-R2					Kendallville D-6			12916	100.00x
Hobart D-1			14972	35.00x	4-21-70	638		George A. Midlam	61
1-14-70	628		Arthur Eland	62	Union City D8B			3641	100.00x
Black Oak-Lake Co.					4-23-70	639		Robert Herrick	49
Cal.-Twp. D-1			214	110.20*	Royal Center D-9A			2153	110.20*
1-14-70	629		Joe McCain	54	5-3-70	640		Leo Strahm	62
Denver D-5			10480	100.00x	Monroe D-7			2248	100.00x
12-21-69	630		Grover Hamilton	83	1-24-70	641		Howard Lightfoot	53
Westville D-3			1912	100.00x	Winona Lake D-5			17217	100.00x
1-29-70	631		Carl O'Briant	71	8-5-69	642		L. M. "Hank" Henderson	71
St. Bernice D-11			3038	100.00x	Winona Lake D-5			4866	110.20*
2-3-70	632		Virgil Richards	60	5-23-70	643		Alonzo "Lon" Daugherty	72
Nineveh D-10			4659	100.00x	East Gary D-1			3382	110.20*
12-12-69	633		James Budd	54	5-26-70	644		Maurice Linder	77
Morgantown (Rural) D-10			4613	45.20*	St. Paul D-10			5047	100.00x
2-26-70	634		Clifford Michael	57					
Forest D-9A			9021	100.00x					
2-26-70	635		Arthur Bieberich	67					
Preble D-7			4211	110.20*					
3-15-70	636		Raymond M. Bloomer	72					
Manilla D-10			13567	100.00x					

Sub-Total Listings (18) 1-1-70 to 6-1-70 - 1731.20
 Sub-Total Listings (35) 6-1-69 to 1-1-70 - 3437.80
 Total deaths (53) to beneficiaries - 5169.00
 (Does not include Memorial Bibles and Markers) See Funeral fund summary following

FUNERAL FUND SUMMARY - WARSAW CONVENTION JUNE 1969 TO

SHELBYVILLE CONVENTION JUNE 1970

	6-1-69 to 12-31-69	1-1-70 to 6-1-70	TOTALS EXTENDED TOTALS
BALANCE ON HAND			41738.21
FUNERAL FUND WARSAW 6-1-69			
Secretary Reports #16 & 17 (68-69)	6.75		6.75
Secretary Reports #4 thru 16 (69-70)	7548.00		7548.00
Secretary Reports #17, 18 & 19 (69-70)		195.75	195.75
Secretary Reports #1, 2 & 3 (70-71)		948.00	948.00
TOTALS (Memberships 11598)....	7554.75	1143.75	8698.50
DISBURSEMENTS			
8-11-69 Memorial Bibles (25)	267.66		267.66
C1 592 thru 626 (35 deaths per listing)	3437.80		3437.80
C1 627 thru 644 (18 deaths per listing)		1731.20	1731.20
Feb.-1970 Bank Charges (New checks)		8.30	8.30
4-16-70 Memorial Bibles (25)		267.60	267.60
TOTALS	3705.46	2007.10	5712.56
BALANCE ON HAND			5712.56
FUNERAL FUND SHELBYVILLE 6-1-70.....			44724.15*

(Clothing, Reserve and General Fund accounts continued on reverse side hereof)

AMERICAN LAFRANCE



"A SINGLE SOURCE OF SUPPLY"

FOR Fire Apparatus and all Fire Department Supplies CONTACT

American LaFrance of Indiana

325 North Main Street Rochester, Indiana 46975
 Phone: Area Code 219—223-2726

FOR Industrial and/or Commercial Fire & Safety Equipment CONTACT

HOOSIER FIRE EQUIPMENT, Inc.

P. O. Box 410 Valparaiso, Indiana 46383
 Phone 219—462-1707

Nick D. Swartz - General Manager

Your Representative will be glad to help you.

JOHN DANAHER 1719 Meharry Street Lafayette, Ind. 47904 Ph. 219—742-4864
 ROBERT IDEN 684 Bond Drive Wabash, Ind. 46992 Ph. 219—223-2726

ONAN LAUGHMAN R. R. 4, 41B1 Willow Ave. Columbia City, Ind. 46725 Ph. 219—691-3332

BUD JOHNSON
 ROCHESTER, INDIANA

Fifth Ambulance For Wayne Township Department

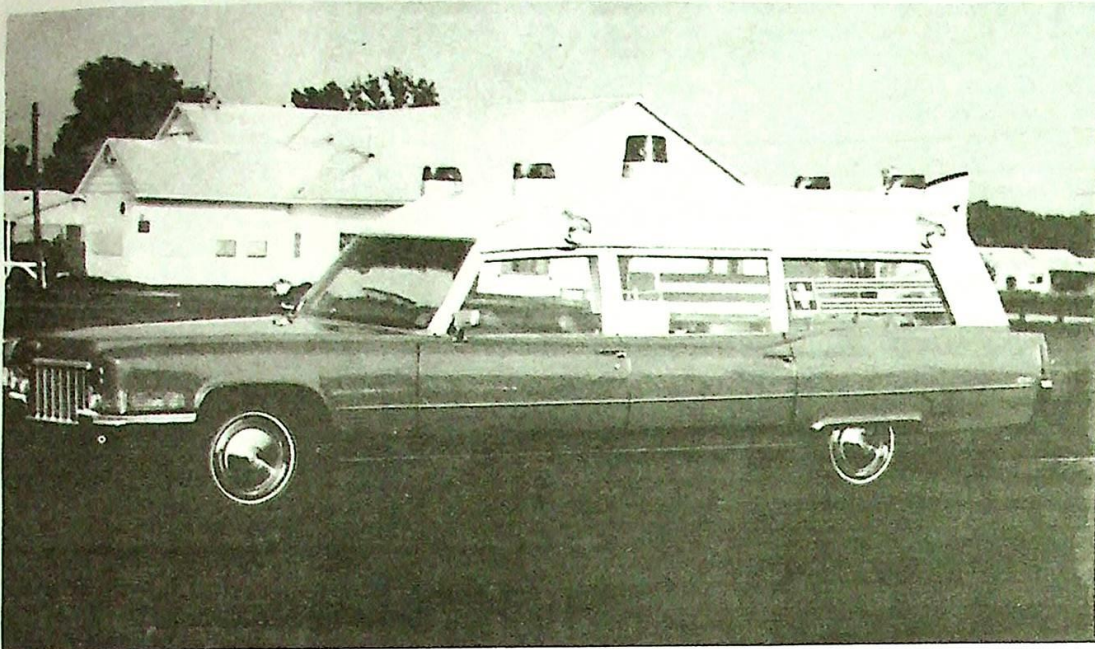

The firefighters of Wayne Township, Marion County, No. 10 station, recently acquired the fifth ambulance for the fire department. The machine, a 1970 Miller-Meteor Cadillac, is shown prior to installation of equipment or radio and before lettering was applied. The Wayne Township departments made over 2000 ambulance runs last year.

Words Of Thanks

We would like to thank the Indiana Volunteer Firemen's Association and Nationwide Insurance Company for presenting myself and our District 12 Chairman, Harold Stofer, a check for \$30,000.00.

This check was delivered to the family of Willis Tharp of Cartersburg, Indiana, a fireman, who lost his life while in the line of duty on April 22, 1970.

I would like to say one thing

to all of you firemen. We here at Wayne Township, Marion County have had pretty sad experiences with different insurance companies, but here was an incident that I thought we were caught in the middle again. We were dispatched to assist Indianapolis Weir Cook Airport on a 747 Airplane fire. Traffic was very heavy and one of our District Chiefs asked Mr. Tharp to help direct traffic and during the process, Mr. Tharp died of a heart attack.

We immediately notified our District 12 Chairman, Harold Stofer, who kept the ball rolling. The next thing we knew, the claim was paid. It appears to us that the Nationwide Insurance has the finest insurance available.

We would like to make one suggestion to all of you members that do not carry this insurance. Please before you wait too long, get hold of your District Chairman and have him explain the program to you. It will be the best money you have ever spent, if it is needed. It doesn't cost that much—it is inexpensive for the coverage you get.

Once again to IVFA and Nationwide, many, many, thanks.

Faithfully yours,
Richard C. Lamb, Chief
Wayne Twp. Fire Dept., Inc.
Marion County, Indiana

ANGOLA BREATHED EASIER
(Continued from Page 6)

traffic and helping to restrict the area. They were assisted by units of the Steuben County Sheriff's Department.

About 9 a. m. sand hauling operations started and many trucks were pressed into service to haul sand. By 8 p. m. 1019 tons or about 150 loads of sand had been hauled in and spread over the area.

The Firemen's Auxiliary served breakfast and lunch to their husbands at the scene and a hot supper was served at the Angola City Hall. The Fremont Fire Department sent men to be on duty while the Angola Firemen left the area for supper.

Approximately 300 man hours were put in by the Firemen according to Chief Goodwin, and they used over 295,000 gallons of water. They returned to the fire station at 11:30 p. m., Tuesday evening.

Angola City Officials said "Angola was sitting on a time bomb all day Tuesday but thank God nobody lit the fuse".

Had there been an explosion or fire it could have caused millions of dollars of damage as well as possible injury to many people. Not only were industries in the area endangered but a major sub station of the Northern Indiana Public Service Company is only 75 feet from the bulk petroleum plant.



Crown Point Fire Department Receives Check From Lions Club

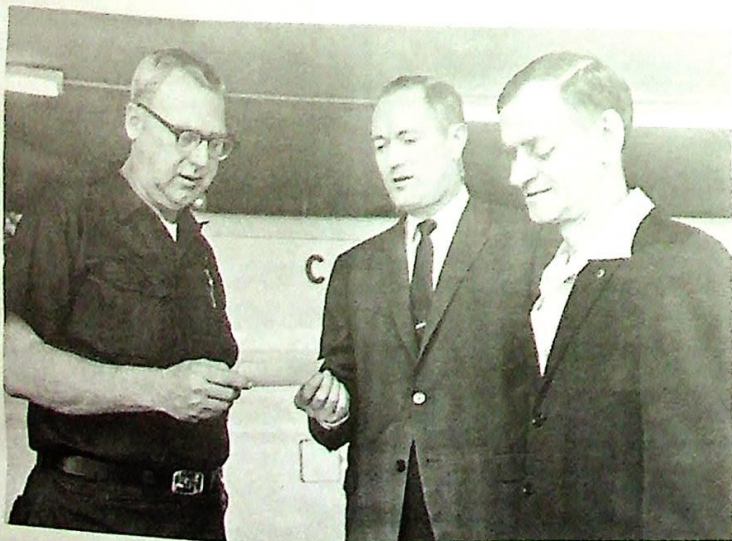

Crown Point Fire Chief C. H. Randolph happily accepts check from Lions Club Treasurer Al Minix, center, and John Miller, a past president. The money will be used for the rescue truck fund. (Post-Tribune Photo)

Etna Green Fireman Weds at Convention



Left to right: Rev. James Horner, Mrs. Betty Miller, Mrs. Thomas Feldman, Mr. Thomas Feldman, Russell Miller and IVFA Chaplain Duane Lantz. Mr. Thomas Feldman and Wilma Oaks were united in marriage on Friday, June 12 at the First United Methodist Church in Shelbyville. The Reverend James Horner performed the ceremony and IVFA Chaplain Duane Lantz made the arrangements.

Etna Green Fire Chief Russell Miller and his wife Betty served as best man and maid of honor.

Bentonville Auxiliary Installed



The officers of the Bentonville Firemen's Auxiliary were formally installed July 14, 1970 at the fire house.

Thelma Lester of Raleigh conducted the candlelight ceremony. She used the Beatitudes of Leadership and followed this with the installation of each officer. Those installed were Barbara Lake, President; Alma Ripberger, Vice President; Pat Summan, Secretary; Sharon Cox, Treasurer; Kathryn Fry, Chaplain, Bernice Pflum and Janet Summan, Directors.

Plans are now being made by the Auxiliary for a Country Store at the fish fry which the firemen will have in the fall.

Left to right: Thelma Lester, Barbara Lake, Alma Ripberger, Pat Summan, Sharon Cox, Kathryn Fry, Bernice Pflum and Janet Summan.

PUMPER - PLUS

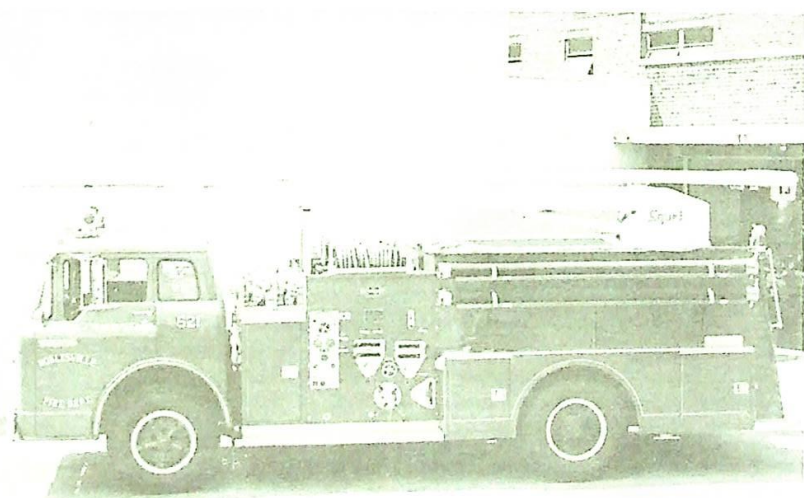

The fire apparatus pictured above is a 1000 gallon per minute class A pumper with all features necessary to meet Bulletin 19. In addition it has mounted the new SQUART articulated boom. A unit identical to the one pictured above is available for delivery immediately. Contact us for more information on the most modern piece of fire fighting apparatus.



MIDWEST FIRE AND SAFETY EQUIPMENT CO., INC.
1605 Prospect St.

(317) 632-9337

Indianapolis, Ind. 46203

Auxiliary News

IVFA Auxiliary Officers 1970-1971

- President Rosella Bousman
R. R. 4, Box 201, Winchester 47394
- Vice-President Carolyn McCarty
Union Mills 46382
- Recording Secretary Jo Lantz
R. R. 1, Box 750, LaPorte 46350
- Corresponding Secretary Joan Shanabarger
Box 74, Churubusco 46723
- Treasurer Verta Engle
3307 Hillcrest Rd., Vincennes 47591
- Chaplain Thelma Lester
R. R. 3, Box 98, Rushville 46173
- Sgt.-at-Arms Catherine Mason
2414 Alma Ave., Fort Wayne 46807
- Immediate Past-President Mary Stafford
Box 151, Waldron 46182
- Installing Officer Pauline Glaub
Manilla, Ind. 46150
- District Chairmen
- District 1 and 2 Clara Shonk
3220 Minnesota, Gary
- District 3 Valerie Pulliam
Box 132, Westville 46391
- District 6 Dorothy Anstett
Pleasant Lake 46779
- District 7 Marjorie Brames
Box 109, Hoagland 46745
- District 10 Barbara Parker
R. R. 15, Box 367P, Acton 46259
- District 11 Vica McGill
Dana 47847
- District 12 Catherine VanArsdale
637 S. Whitcomb Ave., Indianapolis 46241
- District 16 Lois C. Boaz
Box 34, Greenville 47124

Past Presidents

- Ruth Fairfield, 5128 No. Bend Dr. Fort Wayne, Ind. 46804
Inez Jeffries, P. O. Box 85, Fountaintown, Ind. 46130
Catherine Mason, 2414 Alma, Fort Wayne, Ind. 46807
Ruth Ford, 3005 Lincolndale, Fort Wayne 46808
Pauline Glaub, Manilla, Ind. 46150
Loretta Kustron, withdrawn
Vida Bare, moved to Michigan

Committees

- Waterball Donna Brown
1202 Canel St., New Haven 46774
Phone: 219-749-2489
- By-Laws Janet Goodwin, Chr.
300 W. Maumee, Angola, Ind. 46703
Dorothy Anstett Pleasant Lake, Ind. 46779
Ruth Fairfield 5128 No. Bend Dr., Ft. Wayne 46804
- Insurance Ruth Ford
3005 Lincolndale Fort Wayne, Ind. 46808
- Men's Lapel and Auxiliary Pins Lucy Stofer
718 S. Ingomar, Indianapolis 46241

Ladies' Auxiliary Convention

4-H Building, Shelbyville, June 11, 1970

The 1970 Convention got off to a good start with officer's meeting in the fairgrounds and everyone happy to see so many so soon. The meeting was called to order by President, Rosella Bousman, welcoming all guests and members. Prayer was given by Chaplain, Opal Laughman, after which all repeated the pledge to our flag led by Sergeant-at-arms, Catherine Mason.

The Immediate Past President, Mary Stafford, presented a corsage of roses to Rosella to wear during convention. Thanks was extended to the host city and host auxiliaries. Roll call was answered by 19 officers present. Jo Lantz read the minutes of the April meeting.

Treasurer reported the balance to date was \$576.92. Bills were presented. Correspondence read from Catherine Fries and Pat Wade. Chaplain Laughman reported 8 deceased members to be remembered in Memorial Services.

Donna Brown, waterball chairman, reported 9 teams for contest Saturday. A suggestion was given about a Sportsmanship trophy. Decided it should be brought up on convention floor.

Lucy Stofer gave a good report on pins and jewelry. Mary Stafford, chairman of auditing committee, reported the treasurer's books to be in very good standing.

Recording secretary reported 1670 state members from 108 auxiliaries of which 21 are new auxiliaries as to this date. She also showed a chart of the state of Indiana with each auxiliary pin pointed on the map and a certain color designated the auxiliary's district.

Ruth Ford reported that she and Inez Jeffries, the committee, decided on gifts for each officer of the men's association. It was a stainless steel Kreisler pen.

The meeting then closed with prayer by Opal after which the President passed out a nice gift to each of her officers.

Respectfully submitted,
Rosella Bousman, President
Jo Lantz, secretary

I. V. F. A. Auxiliary Officer's Meeting

The meeting was opened with a joint session for the men and women in the Cinema Theatre. After introductions and speeches from all dignitaries of the host city and their Congressmen, all state officers of both organizations were introduced. The auxiliary president, Rosella Bousman, presented each officer of the men's association with a gift from the state auxiliary association. The women were then adjourned to go to their Koffee Klatch.

After meeting old and new friends during the Koffee Klatch, President Rosella Bousman opened the meeting with a welcome to all members and guests. Opal Laughman, chaplain, opened the session with prayer and Catherine Mason led us in pledge to our wonderful flag of the United States.

The convention chairman, Barbara Surber of Acton, introduced their Congressman's wife, Mrs. Bray, and Fire Chief's wife, Mrs. Williamson. All auxiliaries of the 10th District were asked to stand and our thanks to them for a wonderful convention well planned. Beautiful 1970 state emblem charms were presented to the officers, gifts from the 10th District Auxiliaries.

Roll call was answered by 20 officers and 220 women attending the morning session. The recording secretary gave a report we have 108 auxiliaries to date which 21 are new auxiliaries and a membership of 1670.

The treasurer reported the year's total receipts were \$2474.32 with expenses \$1897.40 leaving a balance of \$576.92. Carolyn McCarty, vice-president, reported she now has \$315 turned in on doll tickets and many more yet to sell.

Three door prizes, a radio, a pin and earring set and a chip and dip set, were drawn. It also was announced each member could go to Clinton Variety Store in Shelbyville, ask for the manager and would receive a free necklace.

Meeting was dismissed for joint Memorial Service with eight deceased auxiliary members being remembered.

The afternoon session opened with 240 women in attendance. District Reports were given:

1 and 2—Jean Camp. Met May 12 at Lake Hills Fire Dept., with 31 members present from 6 auxiliaries. New business was the election of officers, with Clara Shonk, 3220 Minnesota, Gary, from Liverpool-Oregon Auxiliary elected as Chairman; Betty Howe, 1912 Edison, Griffith, elected as Secretary. Announced district picnic August 9th at Lake Wood Park at Valparaiso. Next meeting in Merrillville, August 10th.

3—Vallerie Pulliam. Met June 8th at Union Mills with a Pot-luck supper. 7 auxiliaries were present with 31 members. Election of officers were held with Vallerie Pulliam and Mrs. Raymond Tarnow, re-elected chairman and secretary respectively. Carolyn McCarty held installation services for the officers and presented each with a red rose. Next meeting will be at Beatty Hospital in September.

6—Joan Shanabarger. May 21st the meeting was held at South Whitley with 11 members present. Sickness reported and coming events given. Joined the men for refreshments, having a cake decorated with a fire truck. Dona and Dorothy Anstett won a stereo from a raffle by South Whitley.

7—Marjorie Brames. Meeting held at Monroe on May 18 with 11 members from 5 auxiliaries. Doll tickets were passed out. Joined the men for refreshments.

10—Barbara Surber. Met May 18 at Warren Twp. Station No. 2 with 59 members present from 10 auxiliaries. The theme was in keeping with the spirit of the 500 mile race and delicious picnic. Convention discussed. Mary Stafford, Immediate Past President of State Auxiliary, held installation for the new officers, Barbara Parker from Acton as Chairman; Pam Springmeir from St. Paul as secretary; and Donna Bell Beyer from Waldron as Chaplain. Next meeting will be August 17 at Adams. Meeting dismissed.

11—Vica McGill. May meeting was held at Farmersburg with joining the men for a fish dinner, after which 28 women met in a separate room. Helpful hints and discussion for new auxiliaries were told. Thelma Lester, state officer, held installation for new officers. Next meeting will be July 19 at West Terre Haute.

16—Lois Boaz. Met at Elizabeth Fire House May 12 with 13 present from 6 auxiliaries. Distributed doll tickets. Discussed jewelry being sold by the State. Coming events given which are Floyd Knobs (Lafayette Twp.) chicken dinner, July 18 at Community Park; Elizabeth annual chicken and ham dinner the 3rd Saturday in September. Joined the men for a film and lecture on arson. The next meeting will be July 11 at Jackson Twp. (Martinsburg) with election of officers.

Old Business: Verta Engle told that bonding of officers (secretary and treasurer) would cost \$25.00 for a period of 3 years. Jo Lantz made a motion to obtain the bond and Vallerie Pulliam seconded it; carried.

Recording secretary explained membership forms due by September 30. Chaplain asked all names be sent for cards.

Janet Goodwin, By-Laws Chairman, read and discussion held for each resolution of 2 sent in by District 6:

(Continued on Page 9)

cooperation from everyone involved.

I also want to thank the Firemen for the lovely red roses. They made my week end complete.

As we go into a new year, let us all get out and work just as hard as we did the year before to strive to hit the 2000 membership mark for our Men's Silver Anniversary. I know we can do it.

Last but not least let me thank all the ladies of the auxiliaries who re-elected me as their leader of the State. May I with the help of God do better than the year before and not let anyone down. Thanks again to everyone from the bottom of my heart.

Your 1971 State President
Rosella Bousman

Wins Trophy

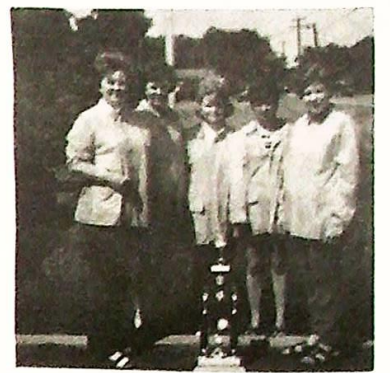

The ladies' auxiliary of Wayne Township Fire Department Co. No. 2, acquired the second place trophy in local water ball competition in June. This competition was held at the New Haven High School. The ladies received the trophy by eliminating the Ashley ladies' auxiliary. The LaOtto Auxiliary took first place.

Pictured above, from left to right, are Hilda Sanders, Ruth Fairfield, Anite Spice, Gloria Fulk and Sarah Birch.

THIRD DISTRICT AUXILIARY

Third District Indiana Volunteer Firemen's Association Auxiliary met on June 8, in the Conservation Building, Union Mills Park, with the Noble Township Auxiliary as host. A delicious pot-luck supper was enjoyed. Host Chaplain Mrs. George Mastern gave the prayer.

The business meeting was then held, with Chairman Val Pulliam in charge. Roll call was answered by 31 members present, representing 7 departments.

The Secretary is to purchase cards and stamps. Mrs. Roy Moore and Mrs. Richard Dillen audited the treasurer's book and found it in order. Mrs. William Pulliam and Mrs. Raymond W. J. Tarnow was re-elected as Chairmen and secretary-treasurer of the Auxiliary. Mrs. Gerald McCarty of the host group was installing officer.

(Continued on Page 9)

Auxiliary President Thanks The Ladies

Now, as our 1970 Indiana Volunteer Firemen's Convention is in the past history, it won't be forgotten very soon.

I want to take this time to thank everyone who attended our convention and especially all my officers and chairmen who helped me through my first year, without them and their help, I could never have done it. I also want to thank all our ladies of the auxiliaries who helped make our Koffee Klatch a 240 success.

As our membership is growing so is our business meetings on Friday. That means more

Citizens Federal Savings and Loan Association

Current Rate on Savings 4 3/4%
Certificates 5 1/4% to 6%
Accounts insured to \$20,000.00 by Federal Savings and Loan Insurance Corporation



1ST MORTGAGE REAL ESTATE LOANS
CONVENTIONAL
IMPROVEMENT
CONSTRUCTION

TOM GALLIVAN
Vice President - Branch Manager
155 North Main Street
Crown Point, Indiana
Phone 663-4758

AUXILIARY MINUTES (Continued from Page 8)

We, the Auxiliaries of the Sixth District recommend an addition to Article VI, Section 5, to be as follows:

At the time of death of an IVFA Auxiliary member, a bible shall be presented to the member's family by the State Auxiliary. The price of the bible not to exceed \$10.00.

We the Auxiliaries of the Sixth District recommend that Article VI, Section I, be amended to read:

An expense allowance of \$35.00 each shall be appropriated to the Recording Secretary and to the Corresponding Secretary at the Convention for postage and any other necessary expenses. Additional expenses will be allowed upon approval of the Board of Directors.

Each were voted for and carried. It also was decided to be the duty of the chaplain to buy the bible.

Recording secretary would have amendment sheets printed and sent with membership cards and By-Law books.

More door prizes such as electric-knife, \$10.00 certificate at Sampler Furniture, figurene, transistor radio, teflon griddle and jewelry were again drawn.

New Business: Jean Camp made a motion and Catherine Van-Ardsdale seconded it to purchase a Sportsmanship trophy to a waterball team, excluding the winner and 1st runner-up. Motion carried. Chairman to buy trophy.

The President called Inez Jeffries to read the duties of each officer as they were voted upon.

Election of new officers: —

President—Rosella Bousman

Vice-President—Carolyn McCarty

Recording-secretary—Jo Lantz

Corresponding-secretary—Joan Shanabarger

Treasurer—Verta Engle

Chaplain—Thelma Lester

Sergeant-at-arms—Catherine Mason

Immediate Past-president—Mary Stafford

More door prizes such as \$5.00, necklace and earrings, wrist watch, wall file, roses, 2 planters and a popcorn popper, were drawn.

Pauline Glaub conducted the installation of officers with Vica McGill as Installing Marshall.

The two beautiful centerpieces were given away for door prizes. Opal closed the meeting with prayer. As each woman left the room, a nice gift bag was given from the group of the 10th District Auxiliaries.

THIRD DISTRICT AUXILIARY

(Continued from Page 8)

She also presented each officer with a red rose from the Noble Auxiliary. Pictures were taken. The Traveling doll was won by Washington Township, having the most members attending. Mrs. Duane Lantz won a game award, and the attendance award was won by Mrs. Roy Moore from the Coolspring Department.

The next meeting will be in September at Beatty Hospital, the date and time to be announced later.

Mrs. Raymond W. J. Tarnow
Secretary

DISTRICT 12

A dinner meeting was held August 6 at Lakeview and the following ladies were installed for the Perry Township Auxiliary.

Pat Babbs - President

Roberta Clayton - Vice President

Jo Hines - Secretary

Trudy Ponslev - Treasurer

Ada Hains - Public Relations

Dorothy Winscott - Chaplain

Joyce Hurst - Marshall

Jeanie Strube and Margarite Hurst - Directors

Perry Township celebrated its 20th Anniversary on August 16.

Wayne Township will hold open house to celebrate and dedicate their new control center August 23 at 1:30 p. m. Everyone is invited.

Mickleyville Co. No. 5 will hold their annual picnic August 16 at Lebanon Park. A very successful Fish Fry this year, new officers elected and several new firemen voted in.

District 12 held their election and Chairman is Catherine Van-Ardsdale; Secretary, Lucy Stofer; Chaplain, Ada Haines; Marshall, Linda Lamb.

DISTRICT 16

Meeting held at Jackson Township (Martinsburg) with

a total of 14 attending. Election of officers was held as follows:

Chairman - Lois Boaz

Secretary - Bonnie Tetleg

Chaplain - Wilma Lawson

Coming Events:

Elizabeth's Chicken and Ham Dinner September 19th.

Georgetown's Jamboree September 13th at Optimist Club.

DISTRICT 6

Meeting held at Kendallville with 22 members present. Election of officers was held.

Chairman - Dorothy Anstett

Secretary - Phyllis Walters

We joined the men for the Convention film and refreshments were served.

Acton Ladies Capture Waterball Title**Wayne Twp. No. 1 Ladies' Runner-up in Waterball****Guess Who?**

The answer will be given in the next issue of the Firemen's paper.

AN ACCIDENT INSURANCE PROGRAM FOR MEMBER COMPANIES OF IVFA

Featuring

- ... Benefits for loss of life, total and partial disability
- ... Increased Weekly Income protection for loss of earnings if disabled
- ... Payment of medical expenses
- ... No territorial restrictions
- ... Your choice of 4 low cost plans
- ... Special features which are over and above those required by the Indiana state law and not usually found in other plans, such as:
 - ... Optional \$30,000 maximum death and total disability benefit
 - ... Choice of \$50, \$75 or \$100 of Weekly Income protection
 - ... Benefits for heart or circulatory malfunction and infectious disease
 - ... Coverage for any non-member over age 16 and under 60 who is specifically requested by a volunteer fire official to assist in an emergency situation
 - ... Coverage for Ladies' Auxiliary units

Member Companies may get complete information on this plan by writing:

JOHN T. FORD, Secretary
INDIANA VOLUNTEER FIREMEN'S ASSOCIATION
 3005 Lincolndale Avenue
 Fort Wayne, Indiana 46808

Underwritten by Nationwide Mutual Insurance Company, Columbus, Ohio

the TASK FORCE TIP

"Throw away 2(Q2) + Q and your hydraulics books!" says Chief C. H. McMillan of the Gary FIRE TASK FORCE, an eight company volunteer operation specializing in heavy streams on major blazes in the heavily industrialized Calumet Region of Northwest Indiana. "This new fully automatic tip will do the figuring for you to always produce the best possible stream from the water available to it."

How many times after a big blaze have the news reports included a statement to the effect that "firemen were hampered by low water pressure"? Today's pumpers are readily capable of any pressure required for firefighting, but only if they have the water to work with. A pumper can and does make pressure, but it can't make water. When too many and/or too large of nozzles are connected to the pumper for the water quantity available, proper pressure cannot be maintained at the nozzles, the consequence being weak and ineffective streams lobbing into the fire, rather than the tearing, penetrating streams necessary to get at the seat of the blaze.

Proper tip sizes can be selected to balance the handlines and deluge devices to apply the available volume at proper nozzle pressure; indeed, this is the main theme of the fire hydraulics manuals. At the training ground or fire school this all works out very well when the layout is carefully pre-planned, calculated, and a minimum of potential troubles (burst line, pumper trouble, etc.) are likely to occur. Plenty of time is available, and most important, usually plenty of water is available, or at least the supply conditions are fairly well known and not subject to change as additional pumpers take suction, level falls in nearby supply watertowers, strainers clog, or relay pumpers fail to pump properly. Under relaxed, comfortable, daylight conditions, the drill-master then walks around with his pitot gauge and predictably measures close to desired pressure on each beautiful stream. If not, (oops, somebody goofed!) a leisurely recalculation and a shut down for a change or two is no problem, even if the necessary tips aren't immediately available, and someone has to drive back to the station to row through a drawer of old spares!

In practice nearly the complete reverse is more likely to be true; as with "Murphy's Law": "Everything that can go wrong, will!" Though most firefighters and chiefs hate to admit it, poor streams are more the rule. Even if the nozzle pressures are not low, they are then usually too high, resulting in unnecessary strain on men and equipment, and undue feathering and breakup of streams. The greater the size of the fire, the greater the chance for error, especially when elevated and master streams are brought into play. Under actual fire conditions even when errors are recognized they are frequently not corrected, for to correct would require a shut down, and there appears to be a general stigma when the fight is hot that a few moments interruption cannot be

afforded, even though to do so may make far more water available. A particular example of this is where a hydrant connection has been made with one or two 2½" lines and a short shut down to change to a large suction will more than double the available volume of water into the pumper. As more and more streams are opened, and especially when big streams are started, all are trying to rob water from each other. Numerous piddling streams pecking at the fringe of the fire and backing up as short reach causes positions to become untenable may satisfy the unknowledgeable that he is doing all he can to put it out. In such cases the fire is not really being fought, but merely being allowed to burn down to a size that can be put out! A few, even just one good master stream can frequently do far more toward getting to the heart of the fire and cutting it down to hand line size.

Chief McMillan can suggest parting with the hydraulics book because the device he has developed (Patent Pending) automatically and continuously solves the master stream hydraulics problems more accurately than could be done with a slide rule and a truck load of nozzle tips, yet the device is very basic and extremely simple. Being a Scotchman with a limited budget, Chief McMillan also designed the device so that it could be applied to existing large fog tips such as the Akron "Black Widow" or Elkhart "Jumbo Select-O-Stream". Smaller versions for use with 1½" and



Task Force Tip being operated on deck gun of Gary FIRE TASK FORCE Squad 225, being pumped through short leads by FTF Engine 212. Note barely visible "lobbing" stream from conventional 1½" tip on deck gun on FTF Engine 215 in background, an example of insufficient water to too large of a tip; in this case about 300 gpm barely making it across the street. **TFT** on Squad 225 is throwing somewhat over 1000 gpm at 100 psi. 2½" handlines are being developed. Although the fog tips with which the device is used are termed "constant gallonage", this refers to maintenance of a constant flow as pattern is varied from straight stream through varying angles of fog pattern. Such tips without the **Task Force Tip** modification have flow variance according to nozzle pressure just as straight bore tips. Actually it is more accurate to say the reverse: nozzle pressure varies according to the flow supplied to the nozzle. Overall performance of any standard nozzle, be it straight bore or fog is pedicated on having sufficient flow supplied to it to fill the fixed opening to the desired pressure.

A short history of the development of fog nozzles should be helpful in understanding the **Task Force Tip** and how it functions. The first fire fighting fog nozzles developed a fog pattern by having a series of holes producing small streams angled so as to impinge to cause a breakup of the pattern. The well known "Navy" (Continued on Page 11)

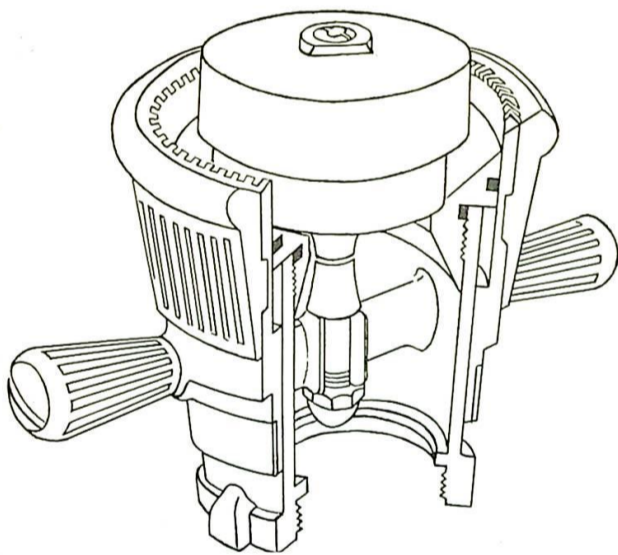

The **Task Force Tip**. Note compact automatic cylinder-baffle mechanism in center of business end of conventional constant-volume fog tip.

CLASSIFIED SECTION

CLASSIFIED ADS

RATES: 25 words or less including name and address\$1.00
TERMS: CASH with advertising copy. Include complete name and address in your ads. Submit legible copy. Publisher is not responsible for errors caused by illegible copy. Type or print all ads. Your cooperation is very much appreciated. Thanks.

CHAMPION

FIRE APPARATUS
FIRE PUMPS
PORTABLE PUMPS
IRRIGATION PUMPS
Write For Catalog
W. S. DARLEY & CO.
Melrose Park, Ill.
STAN KONEFSKY
Distributor
2902 - 178th PL
HAMMOND, INDIANA

PROTECTION

... for everything you have

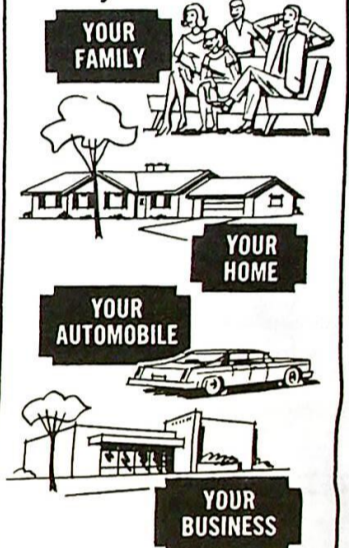

Your Farm Bureau Insurance agent is trained to analyze your present insurance program and adjust it to fit your needs, your goals and your income. Call now for a free consultation.

Farm Bureau Insurance

130 E. Washington St.
Indianapolis, Ind. 46204

PINE TOWNSHIP DEPT. ELECTS OFFICERS

Pine Township Volunteer Fire Department held an election of officers at their regular business meeting in June with the following being named for the coming year:

Chief, Elmer Butts; Assistant Chief, Larry Beck; North Captain, Henry Schulz; South Captain, Eugene Hughtart; Secretary, Adrian Novreske; Inspector, Lester Furness. The officers assumed their duties in July.

BY-LAWS COMMITTEE APPOINTED

President William Goodwin recently appointed a new by-laws committee to study and revise our existing by-laws. Verne Konopasek, State Treasurer of Griffith was appointed chairman and he is to be assisted by Jack Ford, IVFA Secretary, Paul Fairfield, Fort Wayne, Harold King, LaPorte and President William Goodwin of Angola. Their first meeting is to be held on Saturday, August 29 at the Kings Crown Inn at Kokomo.

INDIANA VOLUNTEER FIREMEN'S ASSOCIATION, OFFICE OF THE TREASURER, GRIFFITH, IND.

A NON-PROFIT ORGANIZATION 35 6026503 - AUGUST 1, 1969

COMPARISON OF CONVENTION EXPENSES PAST NINE YEARS

	1962 Greenfield	1963 Angola	1964 New Albany	1965 Rensselaer	1966 Vincennes	1967 N. Haven	1968 Jeffersonville	1969 Warsaw	1970 Shelbyville
Delegate mileage	\$1551.75	\$1905.75	\$2291.28	\$1543.95	\$2482.21	\$1473.15	\$2756.90	\$1668.80	\$1844.05
Officers mileage	387.70	486.37	719.90	597.50	841.10	859.55	982.50	581.59	541.35
Fireworks	75.00	9.02	9.15	None	None	None	None	None	None
Decorations	242.80	157.50	555.00	208.04	21.00	None	128.89	54.24	127.48
Banquet	1582.25	1842.50	2106.00	1467.40	1679.40	2470.95	1491.24	1743.49	2868.00*
Prtg. Convention minutes	321.40	100.00	None	250.00	250.00	250.00	250.00	250.00	250.00
Prtg. Convention book	561.49	858.35	700.23	1281.83	1056.00	836.75	818.50	715.00	987.50
Prtg. Convention tickets	305.50	None	None	None	None	None	None	None	50.70
Prtg. signs, resolutions, etc.	256.00	140.45	234.40	138.45	89.64	255.97	95.73	426.57	255.66
Entertainment	375.00	425.00	716.00	705.00	172.50	375.00	707.50	325.00	275.00
Sound, Conv. cleanup, misc.	247.40	459.90	82.22	427.19	91.09	270.82	71.58*	756.09	269.94
Postage and phone exp.	120.25	82.32	183.03	112.97	175.16	146.67	108.15	229.35	185.86
Registration desk, exp.	145.00	125.00	125.00	145.00	150.00	154.00	26.65	100.00	70.00
Donations, cash prizes	350.00	305.00	None	None	None	None	None	None	None
Conv. Badges, del. & vis.	189.59	180.77	103.48	107.95	103.51	112.20	46.68	123.35	84.10
Prizes donated, conv. tickets	1115.75	None	None	None	None	None	98.90	None	None
Trophies donated for prizes	236.83	374.75	554.57	581.90	334.80	312.26	258.65	201.48	391.00
Other Plaques & Trophies ..		38.10			87.07	30.36	29.69	25.50	24.05
Parade judging exp.					None	None	38.70	None	25.83
Movies, Film, Camera, etc...	599.65	208.29	261.24	519.24	580.00	365.00	485.00	485.00	515.00
Flowers, Memorial Serv.	28.00	34.33	40.29	45.60	28.05	103.33	61.07	40.80	68.19
Conv. Ins. Premium	None	35.00	30.00	None	None	None	None	None	161.00
Rent & Janitor Ser.					300.00	176.50	247.63	95.00	190.00
Court Reporter	145.00	135.00	190.00	90.12	75.00	137.00	74.50	175.00	100.00
TOTALS	\$8836.36	\$7903.40	\$8901.79	\$8522.14	\$8393.03	\$8710.09	\$8778.46*	\$7996.26	\$9284.71

Note: Cash Donations at Convention credit allowances deducted - ** - 353.67* 275.27*
Less cash donations at convention 572.00*

VERNE KONOPASEK, Treasurer

TASK FORCE TIP

(Continued from Page 10)

type nozzle combines an appropriately sized straight bore and interacting shut-off valve in what is still (after better than thirty years) one of the best and most widely used firefighting standbys. The drawback to this type nozzle is the single angle of fog pattern available, as well as variation of nozzle pressure with applied flow. Adjustable fog in firefighting size became available in the next generation of fog nozzles in what amounted to a king-sized version of the old familiar rotary shut-off garden hose nozzle. Here the outer sleeve was movable in relation to a fixed center baffle such that as the outer sleeve was turned, flow varied from shut-off through straight stream to wide fog in the maximum opening. Although many such nozzles were produced and are still widely used, this type of nozzle suffers an inherent problem which magnifies with size. The problem is the variation in flow area with change in pattern; flow is almost twice as great in wide fog as in straight stream, thus it is literally impossible for a pump operator to continuously supply correct pressure, if pattern is being varied. What is worse is that pressure drops most in the fog pattern where it is most desired.

The so called "constant gallonage" fog nozzle was devised as a solution to the above problem. In this nozzle the baffle remains fixed in relation to the body while an outer cylindrical sleeve is moved in or out to shape the desired stream or fog pattern angle such that the flow (and nozzle pressure) remains constant irrespective of pattern changes. This tip does not, however, maintain constant flow with respect to changing supply conditions. A later modification to this type made the baffle movable in relation to the body by addition of an intermediate body such that it could be set for expected flow. Though this type of nozzle has been on the market in handline and smaller sizes for years, its availability in master stream size is relatively recent.

The **Task Force Tip** goes a step further by automatically varying the baffle position to maintain constant water pressure. As one attempts to apply more volume to the nozzle, the nozzle pressure tends to raise; however, with the **Task Force Tip** the baffle quickly repositions at exactly the required greater opening to accommodate the increased volume at the original constant pressure. Conversely, if supply drops, the baffle closes up to again maintain constant optimum pressure. It will handle flow from essentially zero (baffle fully closed) through full design range with less than five psi (not detectable visually, pressure gauge required) change in nozzle pressure. Above this point the tip acts conventionally as a fixed baffle, flow increasing according to the amount of over pressure applied.

The **Task Force Tip** is very compact and fits within the business end of the fog tip, actually inside of the stream in operation. To install, the fixed baffle is screwed out of the conventional tip and replaced by the threaded stem of the **TFT**. The movable baffle is next slipped onto the stem. The outer end of the baffle is also a hydraulic piston. The third major part is the hydraulic cylinder which is slipped onto the baffle-piston (with a return spring between) and screwed onto the outer end of the stem. A small bleed hole in the baffle-piston permits nozzle pressure to communicate to the cylinder chamber; essentially constant pressure is maintained within the cylinder by a bleed off valve located in the center of the cylinder and discharging into the center of the stream. In essence the pressure within the cylinder acting on the baffle-piston balances the nozzle pressure within the nozzle body. Changes in supply result in imbalances which cause the baffle to move to re-establish balance at the proper flow opening according to the supply.

The accompanying photos show the **Task Force Tip** and streams produced with it at varying flows. Of course, the total stream is dependent on both volume and pressure. A greater volume carries greater energy and will move greater air mass, thus achieving greater reach. The point to be made is that the **Task Force Tip** delivers whatever is supplied to it with stream quality equal to the best that can be obtained with a proper tip sized for that quantity. In other words, if but 250 gpm are available, the **TFT** will deliver it in a stream equivalent to a handline with a proper tip for 250 gpm. This might prove especially effective on a ladder pipe where only the flow of one 2½" line is needed, yet to fill a conventional ladder pipe (or elevating platform) would require two or three lines. Also it should be noted that to photograph a stream close enough to show detail in the stream requires getting partially behind it at an oblique angle which may not do justice



Gary FIRE TASK FORCE Squad 225 with **Task Force Tip** operating at 400 gpm with **TFT** maintained 100 psi nozzle pressure. Good stream, good reach for the flow rate (which under fire conditions would be whatever flow available). For purposes of the tests shown, flow from the hydrant through a flow meter was gated down to simulate short water supply.



FTF-TFT operating at 720 gpm with **TFT** maintained 100 psi constant nozzle pressure, a very hefty stream.

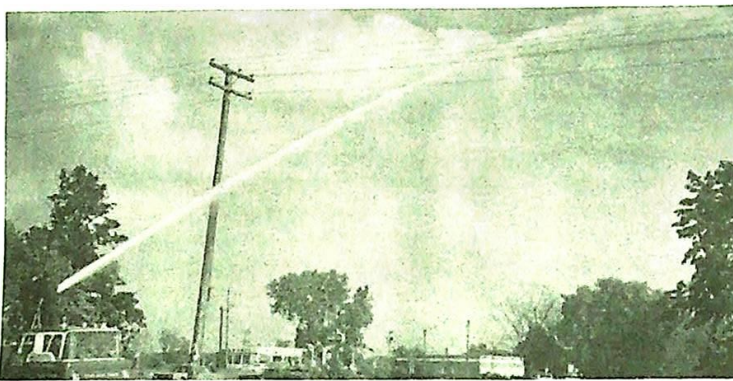

Full bore operation of FTF - **TFT**, 1000+ gpm at 100 psi, a terrific stream with nearly a block's reach and four tons a minute of pure punch!

to the straightness and reach of the stream, thus additional photos from a distance are included to properly illustrate reach.

The **Task Force Tip** can be used with any combination of one, two, three or four 2½" lines, or equivalent flow capacities in larger lines, on deluge sets, ladder pipes, elevating platform pipes, deck guns, etc. The Gary FIRE TASK FORCE has found an excellent lay to be two 2½" (budget doesn't yet permit 3") lines laid straight in from a pumper already at work with one or two handlines. The two lines are then siamesed into the pumper intake and fed through the pump into the direct connected deck gun. Since the FTF pumper is building the necessary nozzle pressure, the supply pumper pressure has only the friction loss to the FTF pumper to overcome. A glance at a friction loss table (maybe the

(Continued on Page 12)

DISTRICT NEWS

(Continued from Page 5)
at Munster on the 19th; the September meeting in District Two and the October meeting at Independence Hill on the 21st.

Robert Esserman
District One Chairman

12TH DISTRICT

The meeting of the 12th district IVFA was held on July 23rd. The host company was Drexel Gardens Volunteer Fire Department Company 6, Wayne Township, Marion County.

At the meeting we ironed out a lot of problems that have come up in the District.

We discussed the need for a better blue light law for volunteer firemen.

Election of officers were held and Harold Stofer was re-elected as district chairman. Charles Bogden was re-elected as district secretary. Bunker Hill, Franklin Township Co. 3 attended the meeting and offered to host next district meeting to be held in September. Postcards will announce dates.

At this time I want to apologize in writing for the mix-up in Bunker Hill's dues. Hope IVFA is back in their good graces. Meeting was closed and refreshments were served.

Harold Stofer
District Chairman

Water Ball, Horse Shoe Contest Opens Parker Fair

Water ball battles and a Jr. horse shoe tournament opened the 20th Annual Street Fair July 15-16-17 and 18th. Water ball fighting turned out into an old fashioned water battles between fire department several times. The audience was dampened on a few occasions as water hose waved from side to side and several unslickered firemen were hosed down by their prankster co-firemen.

Departments participating in the water ball battles were Selma, Ridgeville, Saratoga (Ward Twp.) Farmland and Parker. Chiefs of these departments respectively are Bob Weber, Chuck Richey, Junior Retz, Russell Bennett and Bob Walker. Ridgeville Fire Department was declared battle winner.

An added attraction in the battles was a contest between the ladies' auxiliaries of Ward Twp. and Farmland. Ward auxiliary being the winner.

A BOYER PUMPER

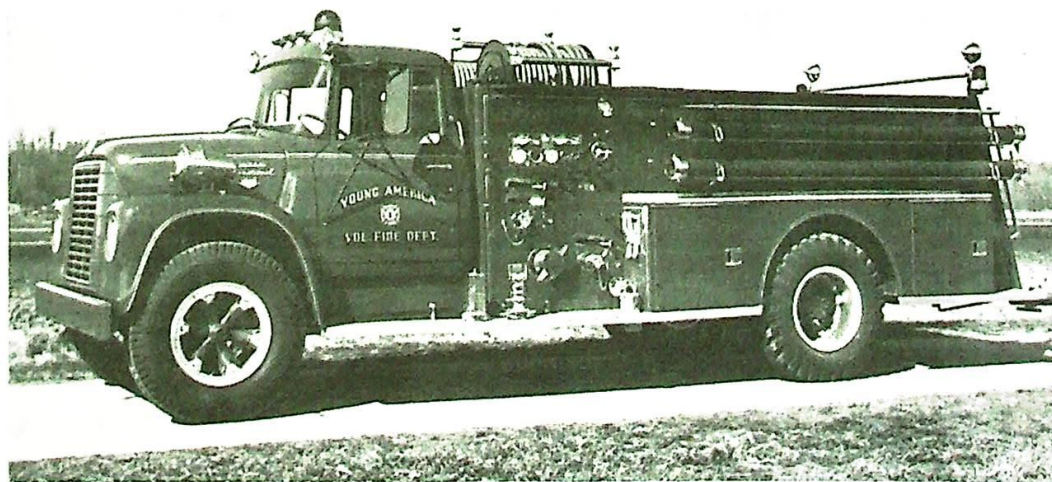

This 600 gallon pumper is mounted on a International 1800 chassis, and is equipped with a Hale QLD-500 Midship pump, two 1½" preconnects at rear and deep compartments for those hard to store fire tools.

WRITE US FOR MORE DETAILS

Universal Fire Apparatus Corp.

MFG. OF THE "BOYER"

P. O. BOX 178

LOGANSPOUT, INDIANA



For
Low-Cost
AUTO LOANS
See
**GARY NATIONAL
BANK**
14 CONVENIENT OFFICES

TASK FORCE TIP

(Continued from Page 11)

book should be kept around for figuring out what you did, after the fire) shows that 500 gpm per line can be moved at a friction loss of 55 psi per hundred feet, thus the supply pumper need maintain only about 120 psi (allowing for a 10 psi residual at the FTF pumper) to supply a 1000 gpm deck stream, if the lines are 200 feet long. What about the line or two already off the supply pumper? Experience has indicated that if the plug is a good one, capable of producing the required flow with 15 or 20 psi residual, a 1000 gpm rated pumper can easily supply the total flow of 1500 gpm. Gary tests produced as high as 2200 gpm (measured with pitot gauge on two deluge sets being supplied) from a rated 1000 gpm pumper, and 2400+ gpm with a 1500 gpm rated engine.

Even if the supply pumper cannot supply as much as might be desired (the operator judges either by pulling the plug down to minimum suction pressure, best judged by using a large soft suction and pulling down to where the suction can be squeezed by hand; or maximum engine load, either as indicated by full throttle or by reaching maximum allowable engine rpm), with the **Task Force Tip** whatever is available, be it 500, 700, or what, is delivered at correct nozzle pressure. If more water is desired at the deck gun, one of the handlines can be put into it, or a third line can be laid to another pumper. An excellent stream will be working all the while, with still greater volume when the third line is charged.

The original **Task Force Tip** was first used at an extra alarm fire in a large hardware store in Gary on July 1, 1968. In the ensuing two years plus, several additional tips have been put in service. Practically every use has demonstrated unforeseen advantages, often permitting master stream use under conditions which would have otherwise been difficult, if not impossible. A prime example was a recent fire in a nearby small town where the hydrant system was capable of only a limited flow. One FTF aerial truck was supplied two lines from a nearby pumper drawing all that was available from the plug, estimated at 450-500 gpm. With the **TFT** this provided an excellent stream with reach all the way across the block. A second **FIRE TASK FORCE** ladder truck was positioned around the corner beside the rear of the fire buildings where only one 2½" line could be had, and through a relay to boot. From time to time a second line could be furnished by tank trucks, a perfect situation for the **Task Force Tip** with a consistently good stream, simply better when the additional flow was available!

While the **TFT** is designed for use with deluge devices, an expensive device is actually not required for effective use of a **Task Force Tip**. A single 50 foot length of 2½" hose taken directly off the pumper and adequately tied about three feet from the **TFT** to a telephone pole, parking meter, car bumper, truck, or any other adequate support can be used for a very creditable deluge stream. Approximately 700 gpm can be pushed through 50' of 2½" hose at about a 50 psi friction loss (105 psi loss per hundred feet by the tables), thus allowing 100 psi for nozzle pressure means that the pumper must operate at 150 psi. A little more or less makes no particular difference to the **TFT**. With a short length of hose, say 25', greater flow can be had.

Another poor man's deluge device which can also be extremely useful even to the department with unlimited budget, carries the above technique one step further by adding a relatively inexpensive siamese ahead of the short length. This set-up is particularly useful on a roof or tied to a cross bar in a window of an adjacent building, and permits two lines to be siamesed into a heavy stream without the bulk of a deluge gun. Use of 3" hose coupled 2½" should be even better.

Wayne Twp., Marion County, Dedicates New Headquarters

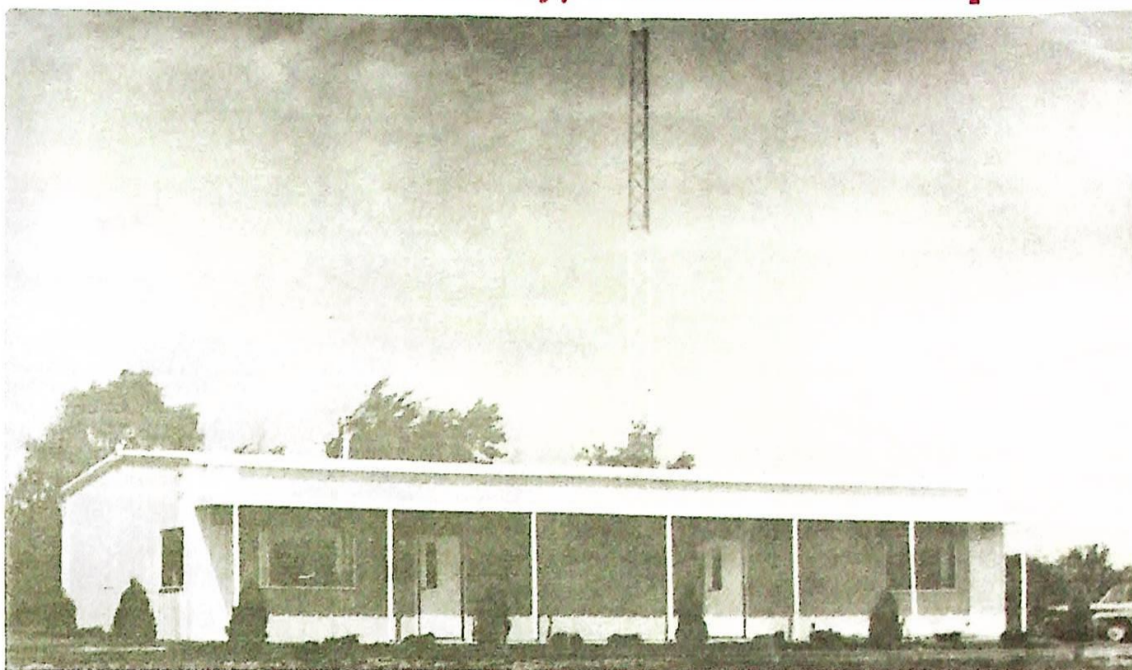

The pictures show the development of Wayne Township, Marion County, new \$50,000.00 fire headquarters. The fire headquarters house a complete radio system that dispatches nine companies in Wayne Township and also dispatches Decatur Township's calls. It also contains offices for the following officers: Chief, Asst. Chief, Training Chief, Fire Prevention Chief and also has a conference room for the executive board and the board of captains. Wayne Township is holding open house Sunday, August 23 to show their new fire headquarters to the public. The time will be between 2:00 and 5:00 Everyone invited.

Wayne Township is also starting their 1970 fire school. It was broken down into two courses. A regular course and an advanced course. We had approximately 150 firemen attending these classes. The advance course schedule was as follows: Captain Schmidt on aircraft fire fighting on August 5; Larry Kuhner on electrical hazard August 12th; flammable gas course on August 19; Battalion Chief Roland Walls attacking major fires on August 26th.

The narcotics course will be on September 2nd, Randy Harnish on sprinkler systems September 9, Gene Haveleath on petro fires September 16th. The advance course and speakers classes will be held at Rockville Rd. Co. 9, 6448 West Ohio St., Wayne Township, Marion County, Indiana. This will be well worth your time if you can catch any or all of these meetings. After school we will hold a graduation dinner-dance to honor graduating firemen.

Liverpool-Oregon Captures First Place Waterball Trophy at District I and II Competition



Pictured above are members of the winning Liverpool-Oregon Waterball team. They were awarded the first place trophy at the recent District I and II competition held at Chesterton.

REGISTRATIONS NOW BEING ACCEPTED FOR RESUSCITATOR SCHOOL

The 1st and 2nd District of the IVFA is going to conduct a 2 day Resuscitator Operator's School on Saturday, September 26 and October 3 at the Merrillville High School, 276 East 68th Avenue.

This school will be on all types of inhalators, how to use them and how they operate. The school will be put on by the Renaldi Company, with outstanding men as instructors. The school will be held on two Saturdays, with each session being a full day. The classes will start at 8:30 a. m. and run until 12:00, from 12 to 1 lunch will be served in the school cafeteria, then back to class at 1 until 4. Registration will start at 8:00, at which time coffee and donuts will be served.

After the last session on Saturday, October 3, there will be a social hour and the certificates will be given out.

After several meetings the committee decided on a very low figure of \$10.00 per man. This cost is for the barest necessities of putting this school on. For your \$10.00 fee you will get a manual on inhalators and resuscitators, 1 meal each Saturday, arm patch, a certificate, and refreshments at the social hour after the last session is over.

Make the check or money order payable to District 1 and 2 Resuscitator School. The deadline for the registration is September 1, so make your reservations early to make sure you will gain the knowledge that will be available through this school in life saving equipment that is in use at your station.

It will be of great value to yourself, your department and community to be able to perform your duties more efficiently with the inhalator and resuscitator. The registration will be limited to 300 for this type of school.

Send all registrations to Robert Esserman, Chairman, R. R. 1, Box 354, Chesterton, Indiana 16304.

Represented by: E. L. SCHULTZ Silver Lake, Indiana; RUSS MANIFOLD Anderson, Indiana; DICK LAMB Bridgeport, Indiana; MARK TURNER Indianapolis, Indiana; M & S FIRE & SAFETY EQUIP. CO. Evansville, Indiana



Elkhart, Akron, Wooster Brass Nozzles — Fire Hose and Booster Hose — Extinguishers — Sirens — Complete equipment for Every Department's Needs.

LOOK TO HOWE... FOR THE LATEST IN FIRE APPARATUS



HOWE

"dependable fire apparatus since 1872" FIRE APPARATUS COMPANY 1402 W. 22nd St., Anderson, Ind.